





CAJA 238-II





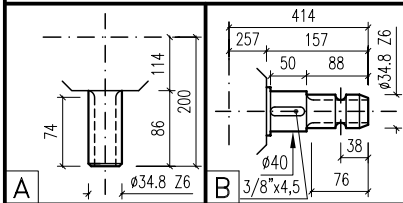
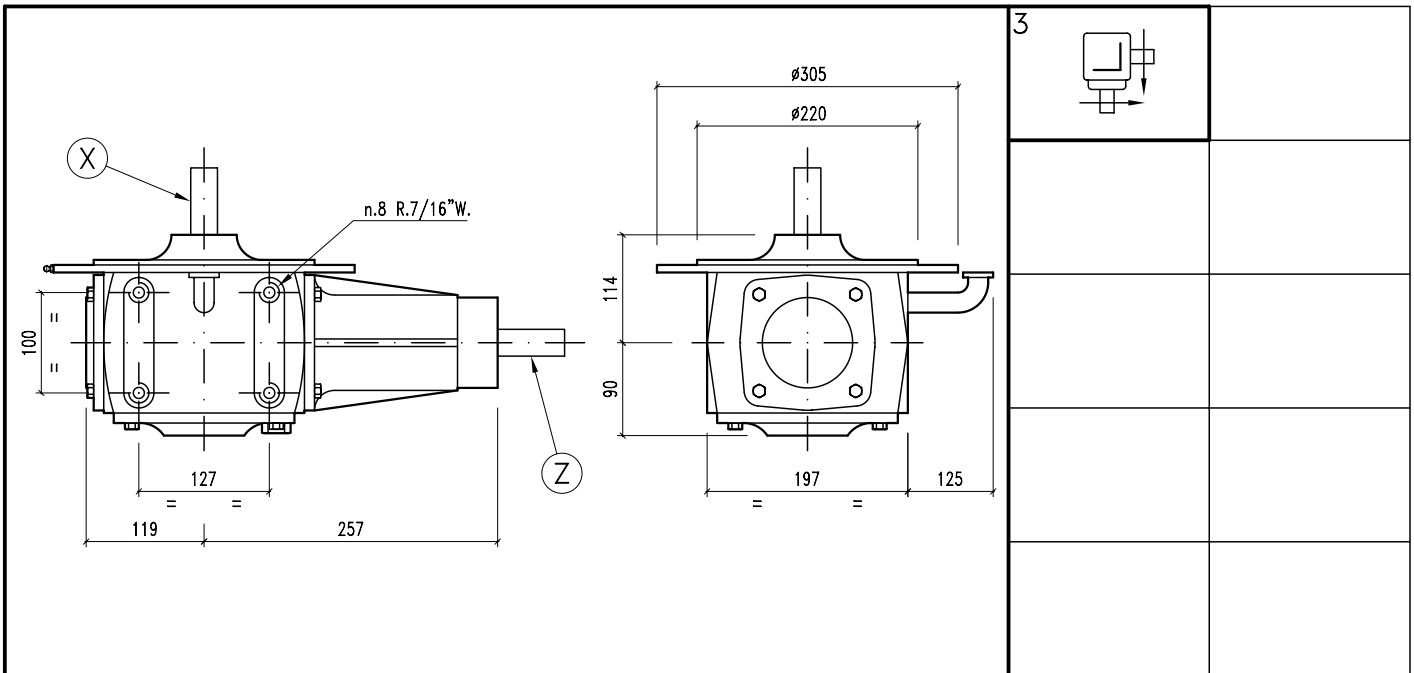





ALGUNAS POSIBILIDADES DE USO:

* Acoplados tolva autodescargables.

	34
	SAE 90



													
	i	r.p.m.	HP	KW	X	Y	Z	ARMADO	ENTRADA		CODIGO		CODIGO
	1,5:1	540	55	40,45	A		B	3	Z	3	65		

