





# CAJA 238-IV

## ALGUNAS POSIBILIDADES DE USO:

\* Acoplados tolva autodescargables.

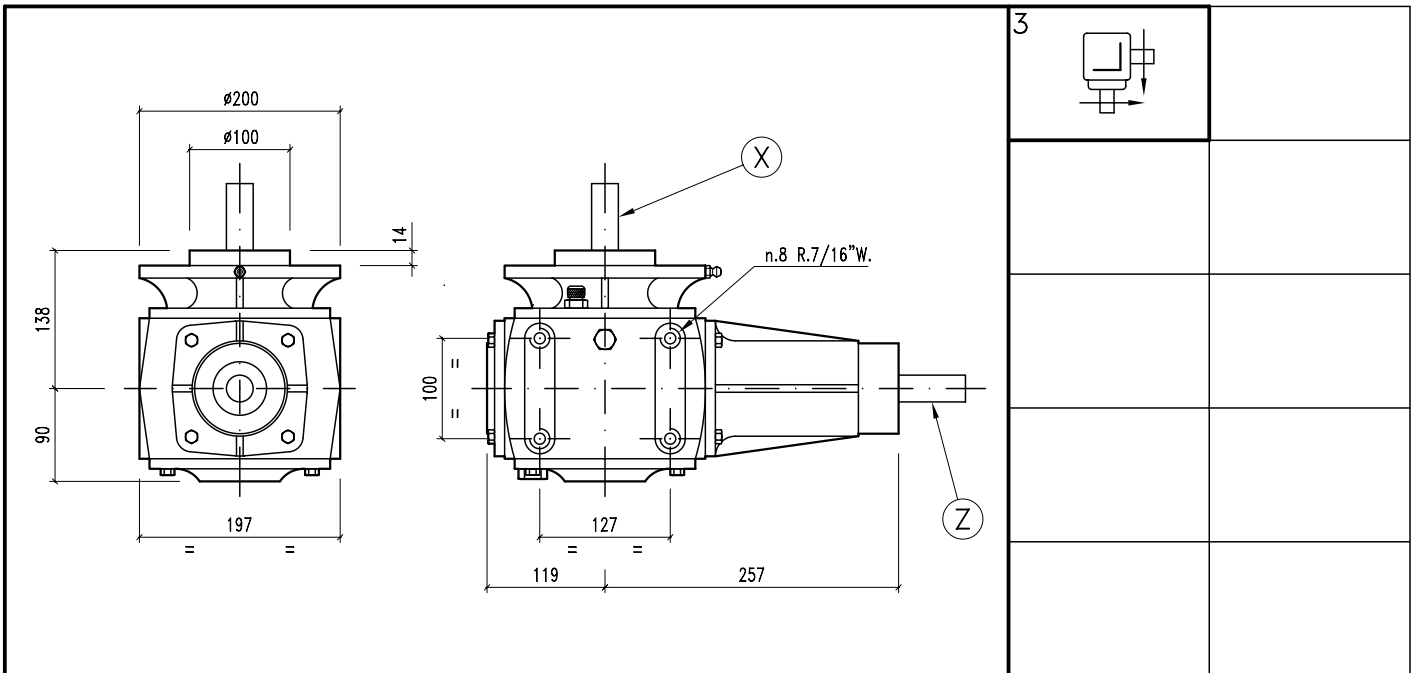
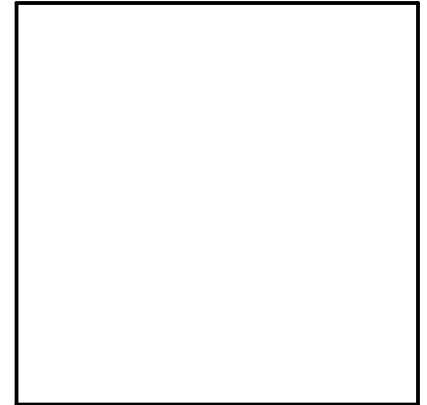





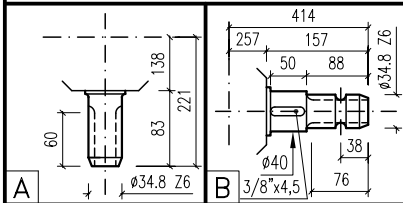



	32
	SAE 90





--	--	--	--	--	--	--	--	--	--	--	--	--

													
	i	r.p.m.	HP	KW	X	Y	Z	ARMADO	ENTRADA		CODIGO		CODIGO
	1,5:1	540	55	40,45	A		B	3	Z	3	2		

