



# CAJA 238-VII

## ALGUNAS POSIBILIDADES DE USO:

\* Trituradoras.



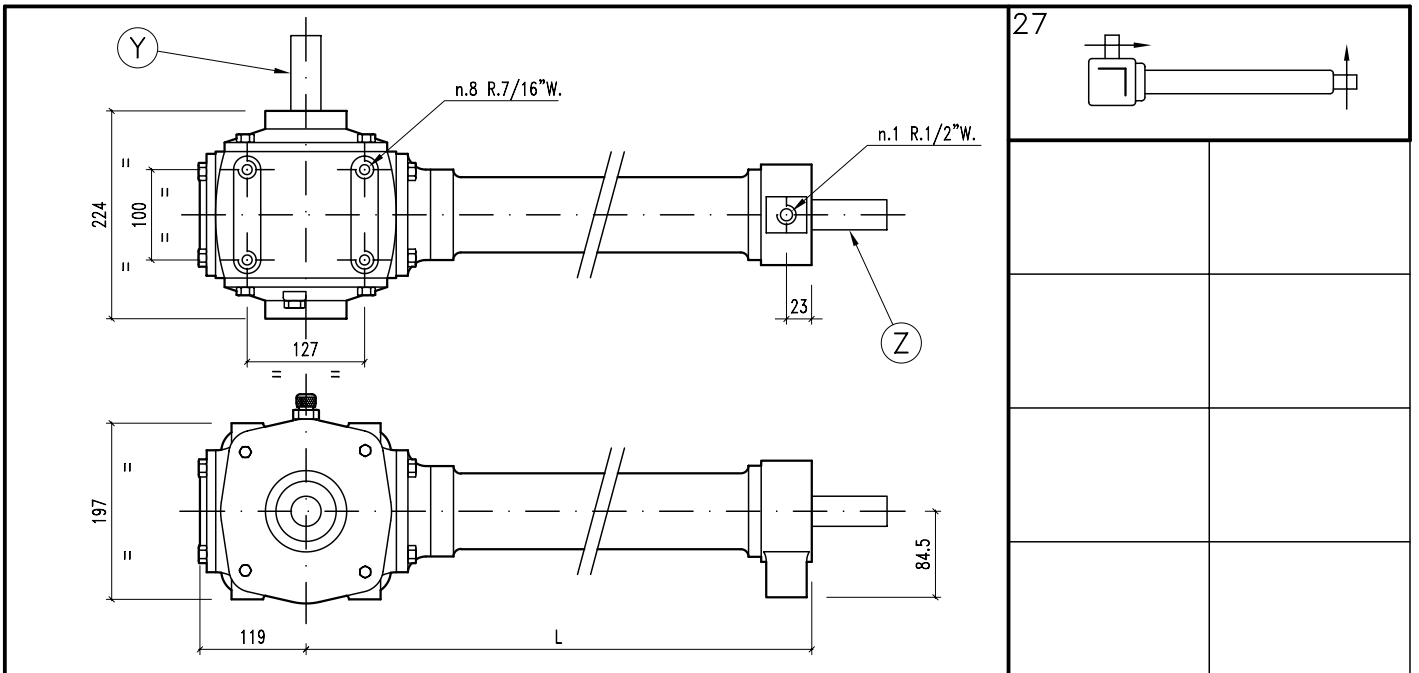
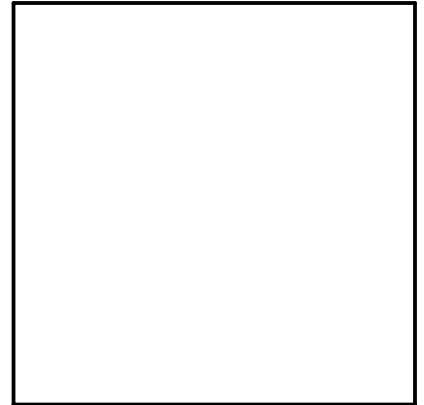

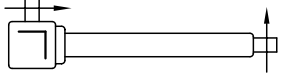

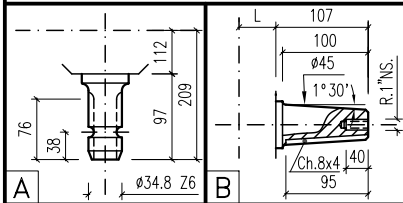

	38,5
	SAE 90



27	



--	--	--	--	--	--	--	--	--	--	--	--	--	--

↑															
	i	r.p.m.	HP	KW	X	Y	Z	ARMADO	ENTRADA	L		CODIGO		CODIGO	
	1:2	540	60	44,13		A	B	27	Y	segun necesidad	27	74			

