





# CAJA D.342 RF

## ALGUNAS POSIBILIDADES DE USO:

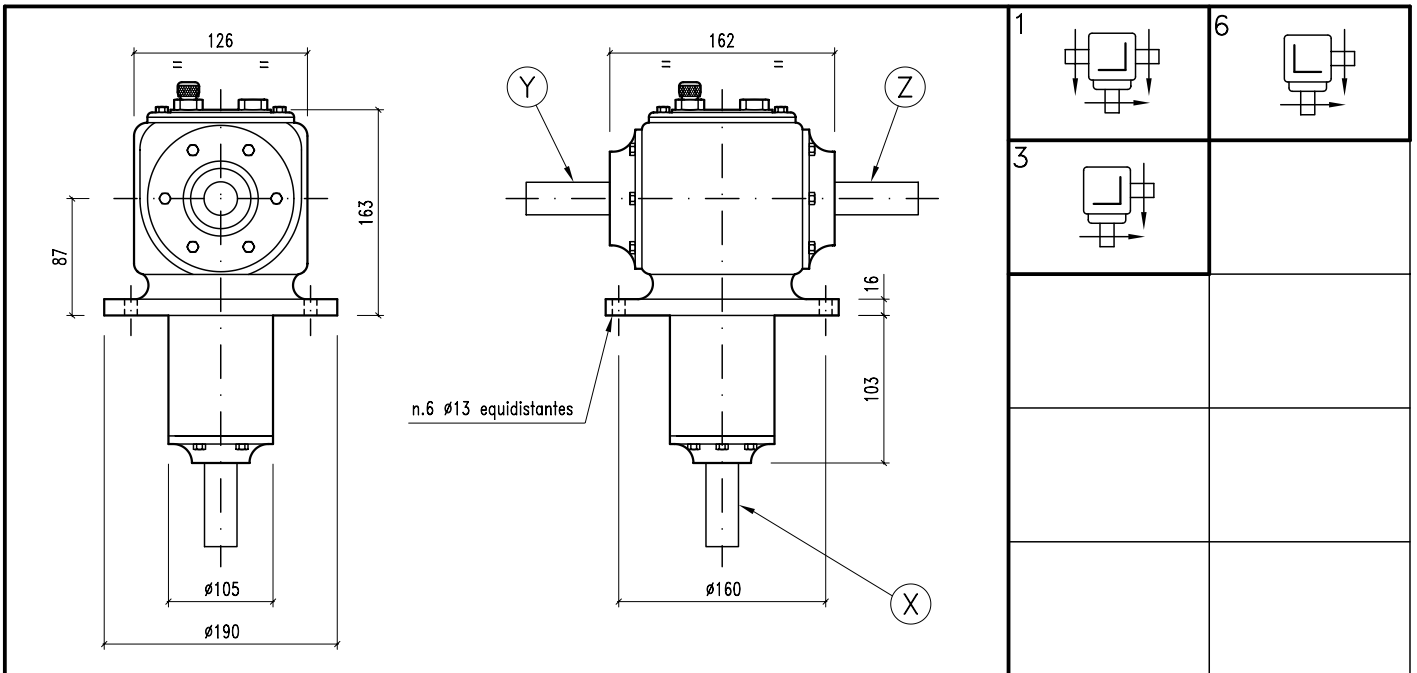

\* Cortadora de cesped.

	16,5
	SAE 90

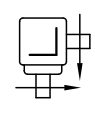

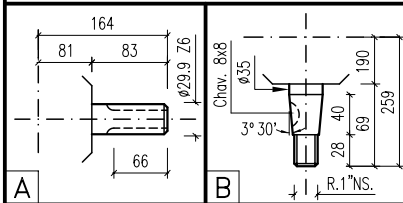
1		6	
3			



i	r.p.m.	HP	KW	X Y Z			ARMADO	ENTRADA	CODIGO		
				X	Y	Z					
1:1	540	23	16,92	B	A	A	1	Y-Z	1	341	
1:1	540	23	16,92	B		A	3-6	Z	3	148	6 149

