





CAJA D.344

ALGUNAS POSIBILIDADES DE USO:



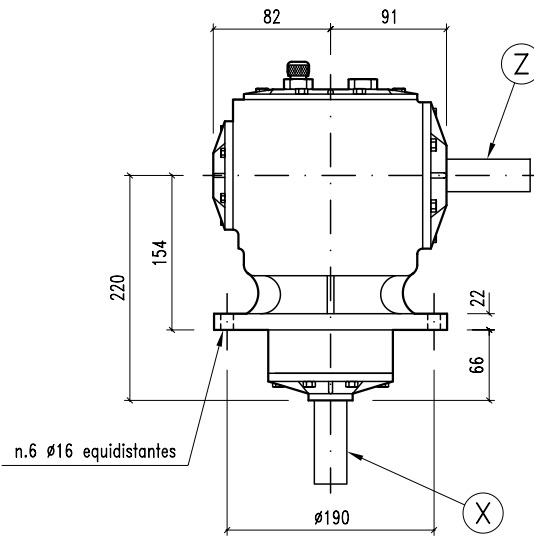
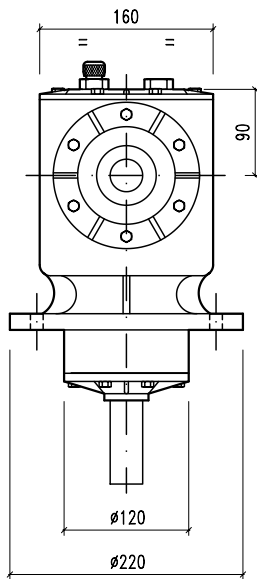



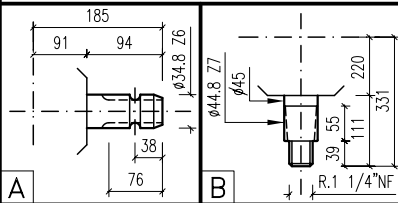

* Desmalezadoras.

	28,5
	SAE 90



3		6	



↑													
	i	r.p.m.	HP	KW	X	Y	Z	ARMADO	ENTRADA		CODIGO		CODIGO
	1:1,5	540	56	41,19	B		A	3-6	Z	3	146	6	147

