











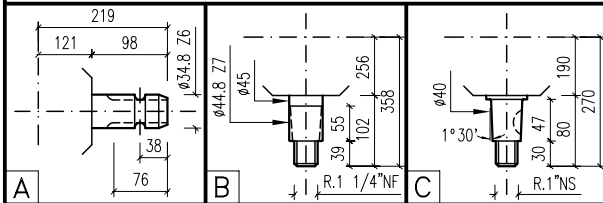
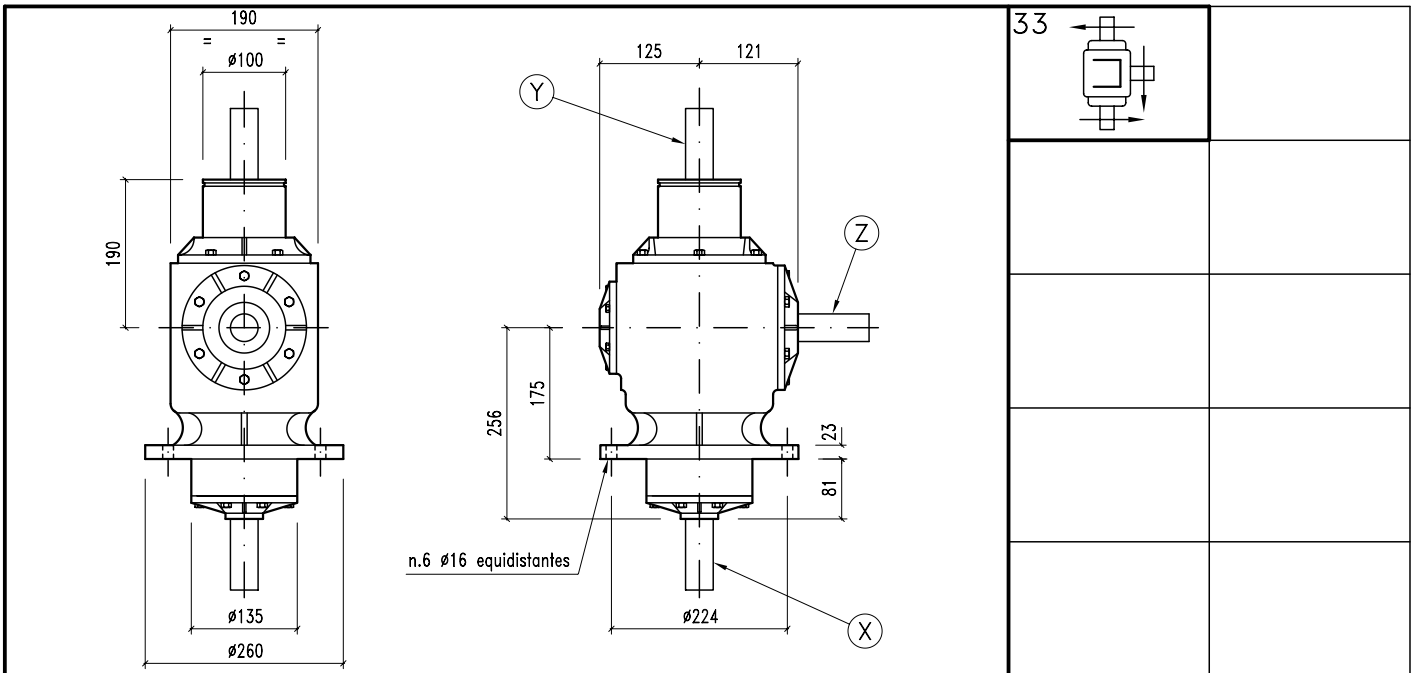

CAJA D.346-XXI

ALGUNAS POSIBILIDADES DE USO:

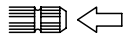
* Desmalezadoras.

	47
	SAE 90



													
	i	r.p.m.	HP	KW	X	Y	Z	ARMADO	ENTRADA		CODIGO		CODIGO
	1:1,5	540	64	47,07	B	C	A	33	Z	33	118		

