







# CAJA D.346

## ALGUNAS POSIBILIDADES DE USO:

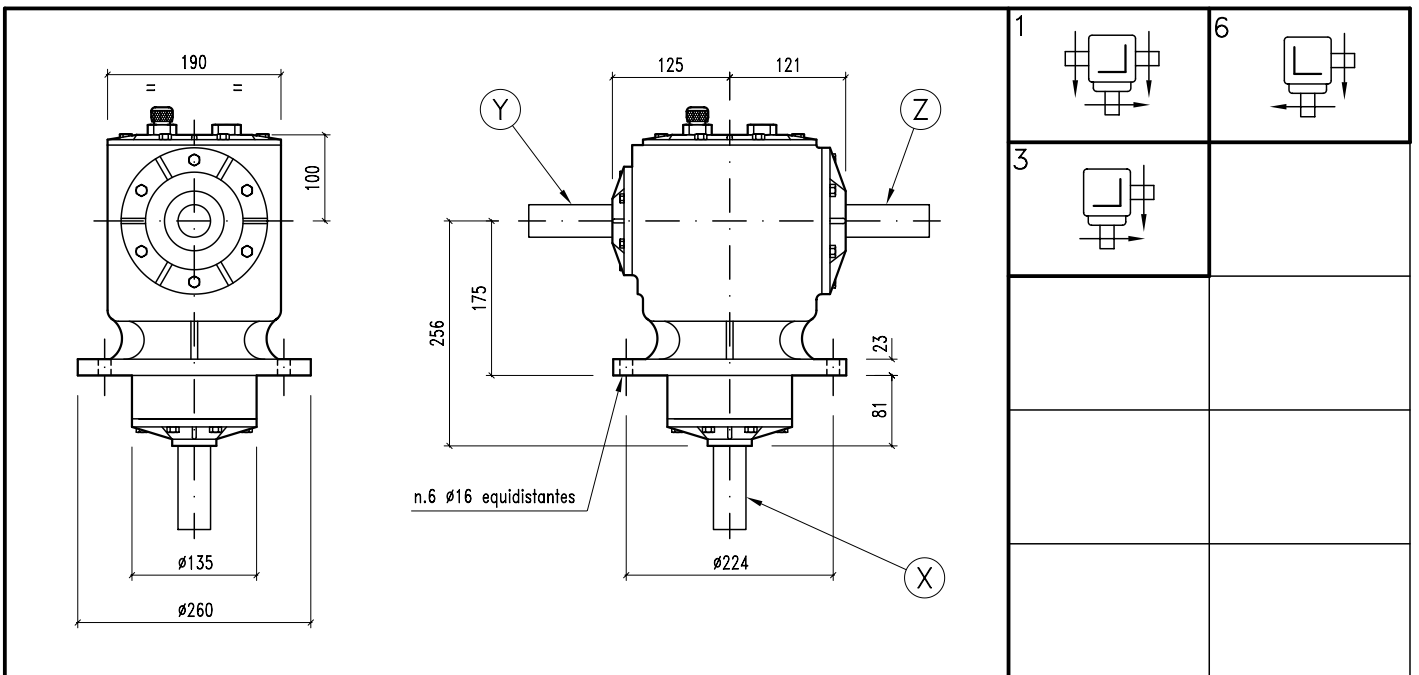
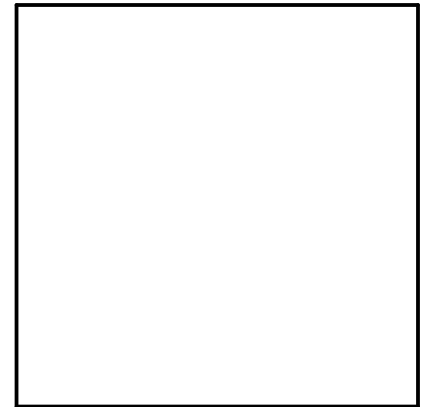
- \* Desmalezadoras.
- \* Desmalezadoras-hileradoras.
- \* Desmalezadoras articuladas.

	45
	SAE 90



1		6	
3			



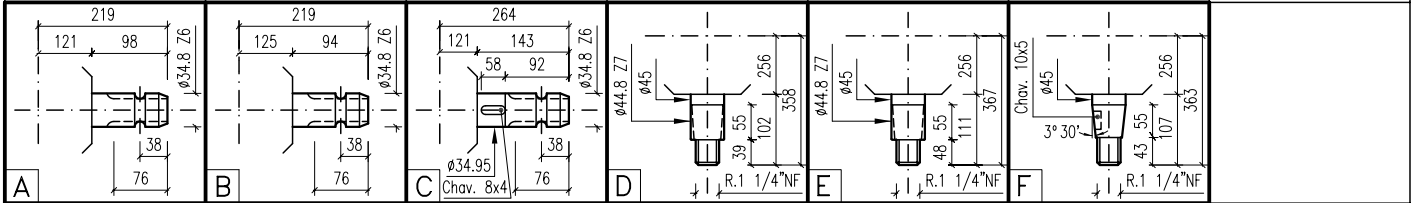





--	--	--	--	--	--



--	--	--	--	--	--



# CAJA D.346

												
i	r.p.m.	HP	KW	X	Y	Z	ARMADO	ENTRADA		CODIGO		CODIGO
1:1	540	73	53,69	D	B	A	1	Y-Z	1	250		
1:1	540	73	53,69	E	B	A	1	Y-Z	1	251		
1:1	540	73	53,69	F	B	A	1	Y-Z	1	252		
1:1	540	73	53,69	D		A	3-6	Z	3	106	6	253
1:1	540	73	53,69	E		A	3-6	Z	3	254	6	255
1:1	540	73	53,69	F		A	3-6	Z	3	256	6	257
1:1,33	540	67	49,28	D	B	A	1	Y-Z	1	258		
1:1,33	540	67	49,28	E	B	A	1	Y-Z	1	259		
1:1,33	540	67	49,28	F	B	A	1	Y-Z	1	260		
1:1,33	540	67	49,28	D		A	3-6	Z	3	235	6	261
1:1,33	540	67	49,28	E		A	3-6	Z	3	262	6	263
1:1,33	540	67	49,28	F		A	3-6	Z	3	264	6	265
1:1,5	540	64	47,07	D	B	A	1	Y-Z	1	237		
1:1,5	540	64	47,07	E	B	A	1	Y-Z	1	238		
1:1,5	540	64	47,07	F	B	A	1	Y-Z	1	239		
1:1,5	540	64	47,07	D		A	3-6	Z	3	100	6	240
1:1,5	540	64	47,07	E		A	3-6	Z	3	104	6	182
1:1,5	540	64	47,07	F		A	3-6	Z	3	241	6	266
1:1,5	540	64	47,07	D		C	3	Z	3	268		
1:1,5	540	64	47,07	E		C	3	Z	3	269		
1:1,5	540	64	47,07	F		C	3	Z	3	270		
1:1,69	540	60	44,13	D	B	A	1	Y-Z	1	242		
1:1,69	540	60	44,13	E	B	A	1	Y-Z	1	243		
1:1,69	540	60	44,13	F	B	A	1	Y-Z	1	244		
1:1,69	540	60	44,13	D		A	3-6	Z	3	105	6	245
1:1,69	540	60	44,13	E		A	3-6	Z	3	246	6	247
1:1,69	540	60	44,13	F		A	3-6	Z	3	248	6	249

		 <b>GARRO FABRIL S.A.</b>				