



# CAJA D.346 RL

## ALGUNAS POSIBILIDADES DE USO:

\* Desmalezadoras.



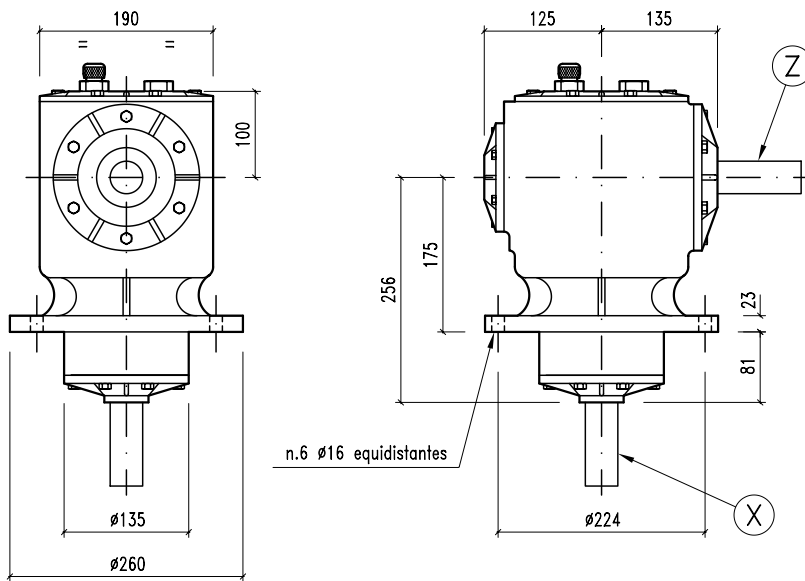





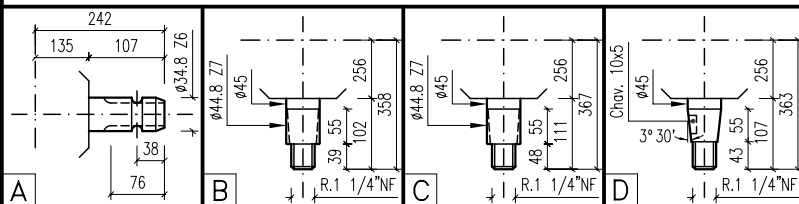

|   |        |
|---|--------|
|  | 48     |
|  | SAE 90 |



Nota: CON RUEDA LIBRE INCORPORADA.

3



|   |  |  |  |  |  |  |  |        |         |   |        |   |        |
|---|---|---|---|---|---|---|---|--------|---------|---|--------|---|--------|
|   | i   | r.p.m.  | HP  | KW  | X   | Y   | Z   | ARMADO | ENTRADA |  | CODIGO |  | CODIGO |
|  | 1:1,5   | 540   | 64  | 47,07   | B   |   | A   | 3      | Z       | 3   | 189    |   |        |
|   | 1:1,5   | 540   | 64  | 47,07   | C   |   | A   | 3      | Z       | 3   | 317    |   |        |
|   | 1:1,5   | 540   | 64  | 47,07   | D   |   | A   | 3      | Z       | 3   | 318    |   |        |
|   |   |   |   |   |   |   |   |        |         |   |        |   |        |
|   |   |   |   |   |   |   |   |        |         |   |        |   |        |

