



# CAJA D.347-IV

## ALGUNAS POSIBILIDADES DE USO:

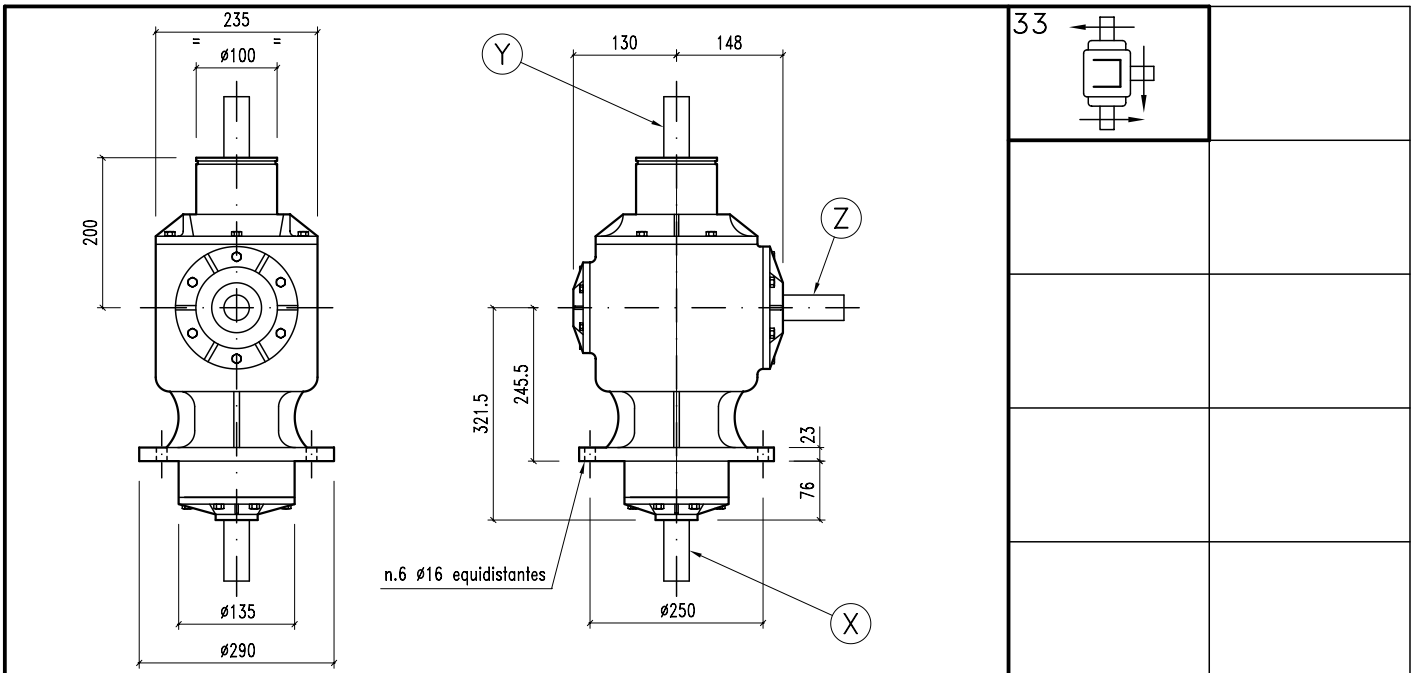

\* Desmalezadoras.

	64,5
	SAE 90

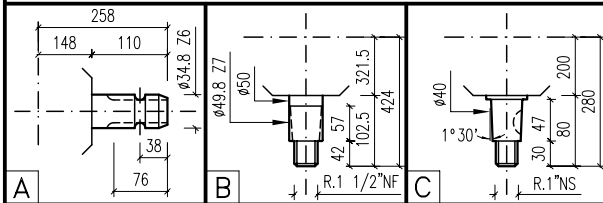
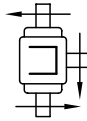

33



i	r.p.m.	HP	KW	X Y Z			ARMADO	ENTRADA	CODIGO	
				X	Y	Z				
1:1,33	540	100	73,55	B	C	A	33	Z	33	187

