







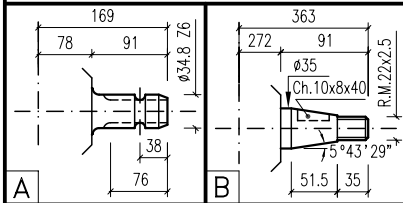
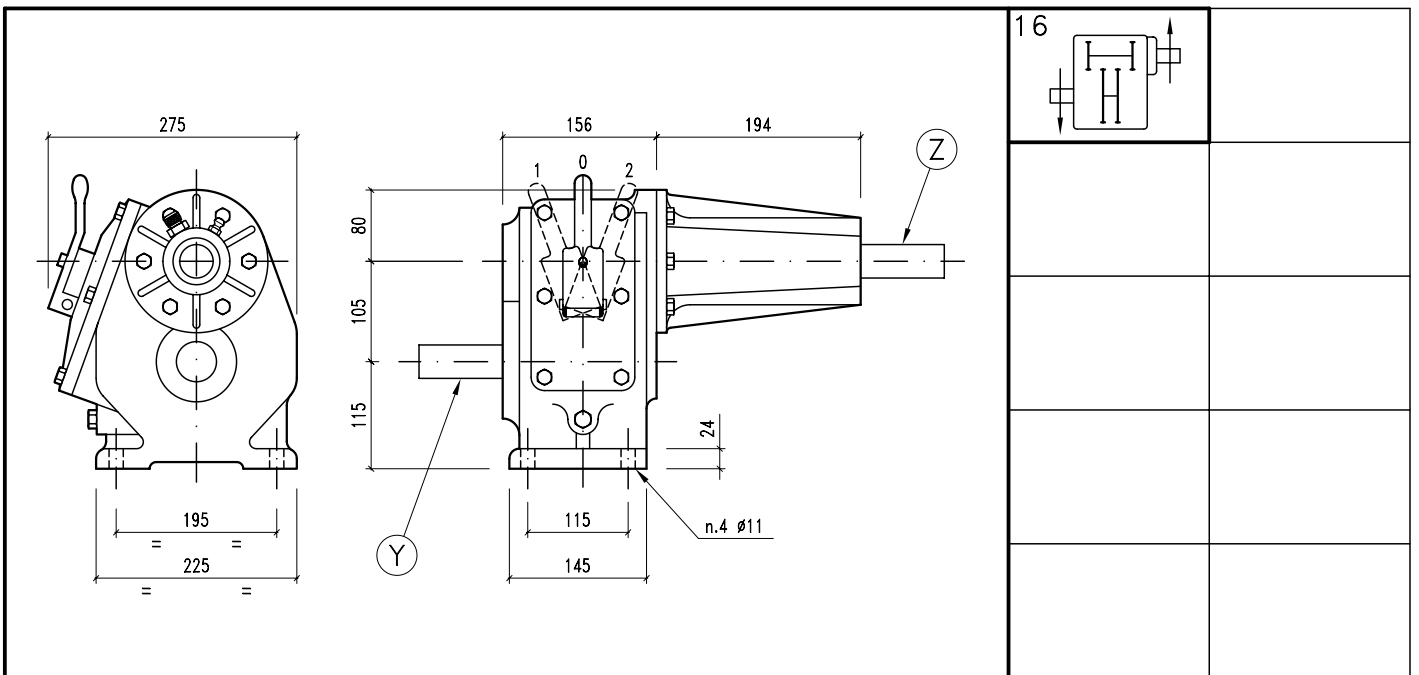
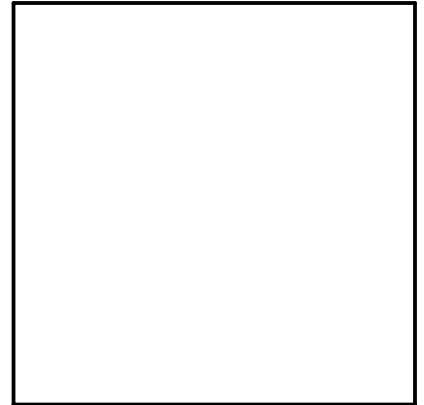

MULTIPLICADOR F1-2

ALGUNAS POSIBILIDADES DE USO:

- * Pulverizadores.
- * Atomizadores.

	35,5
	SAE 90



i	r.p.m.	HP	KW	X Y Z			ARMADO	ENTRADA	CODIGO			
												
POS. 1	540	32,5	23,90		A	B	16	Y	16	161		
POS. 2	540	37,5	27,58		A	B	16	Y	16	161		

* RELACIONES DE TRANSMISION:  POSICION 0 - NEUTRAL
 POSICION 1 - 1:3,5
 POSICION 2 - 1:4,06

