







MULTIPLICADOR G1-2

ALGUNAS POSIBILIDADES DE USO:

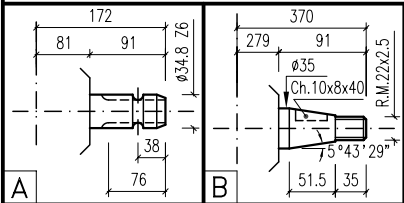
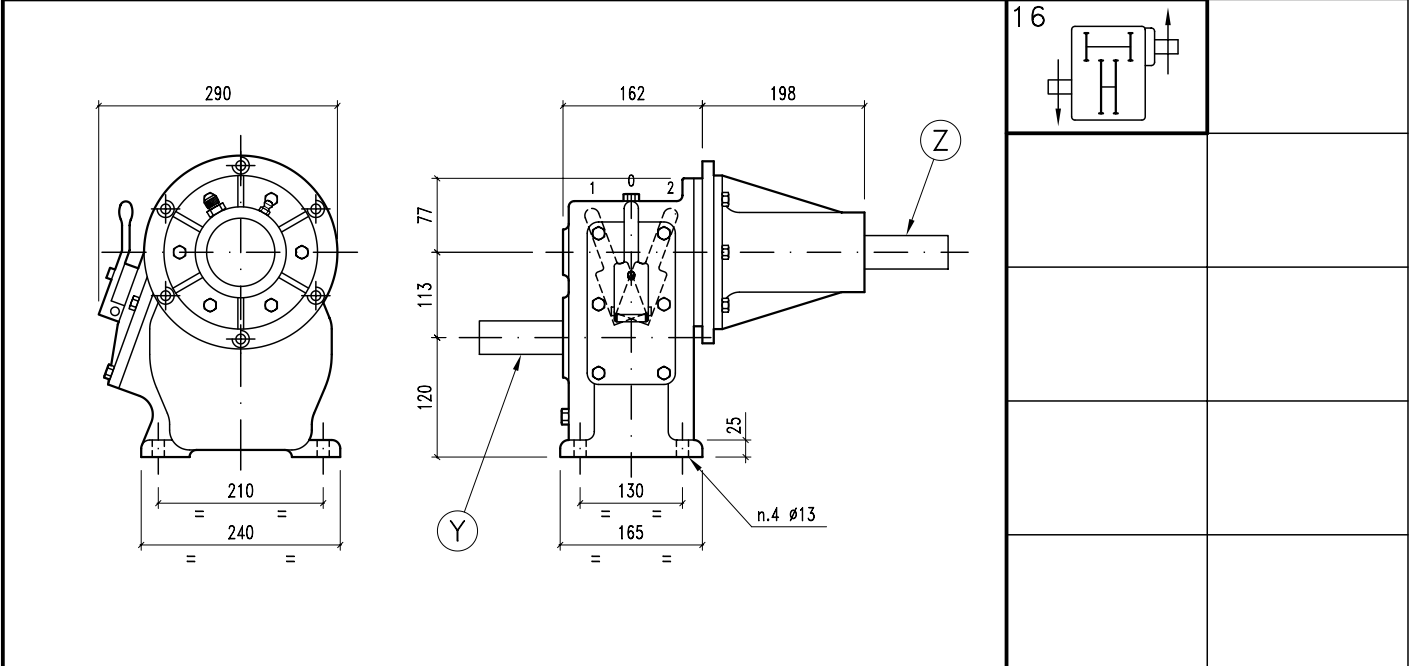
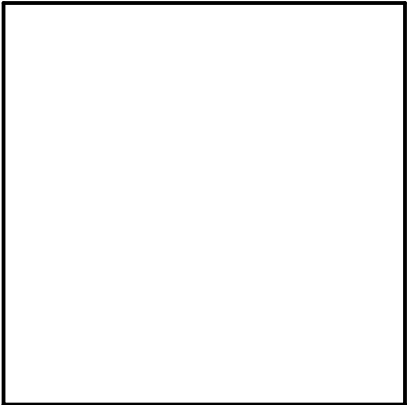
- * Pulverizadores.
- * Atomizadores.

	48,5
	SAE 90

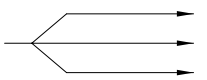

i	r.p.m.	HP	KW	X	Y	Z	ARMADO	ENTRADA				
										CODIGO		CODIGO
POS. 1	540	50,5	37,14		A	B	16	Y	16	160		
POS. 2	540	56,6	41,56		A	B	16	Y	16	160		

* RELACIONES DE TRANSMISION: 

POSICION 0 - NEUTRAL
 POSICION 1 - 1:3,88
 POSICION 2 - 1:4,92

