





CAJA G.456-25P

ALGUNAS POSIBILIDADES DE USO:

- * Esparcidores.
- * Transmisiones.

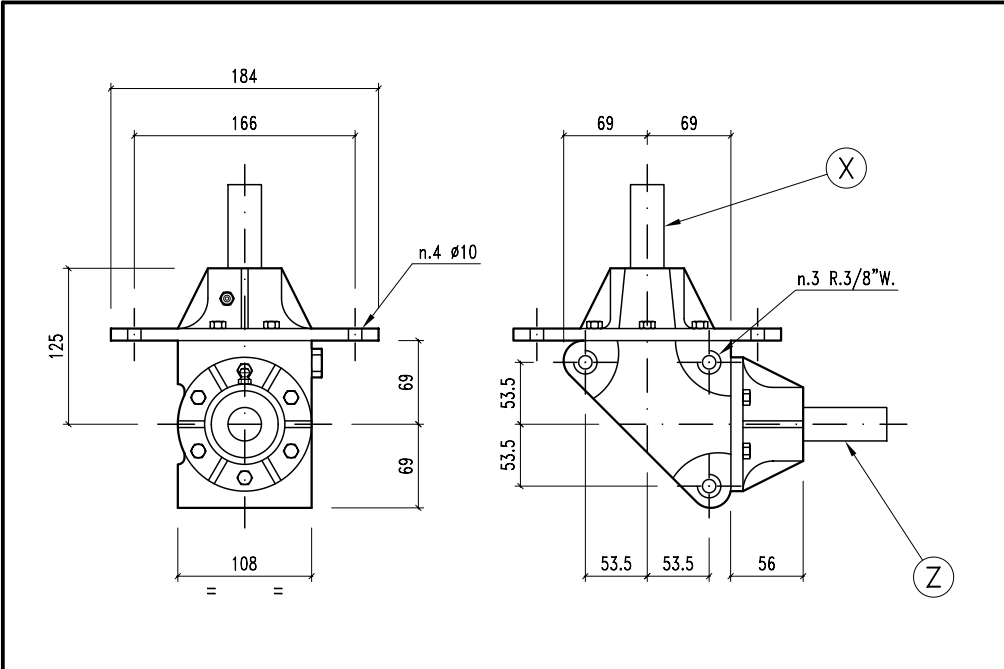
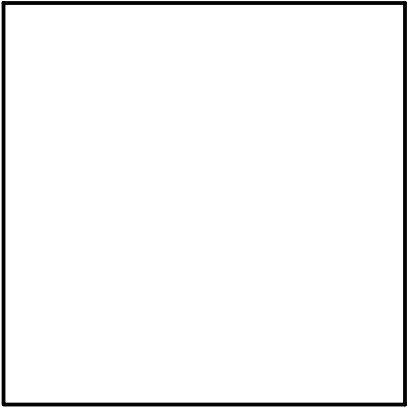





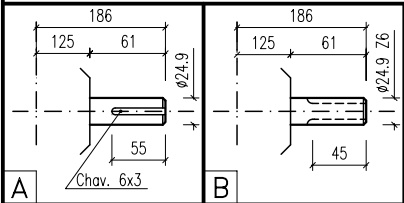

	11
	SAE 90



9		

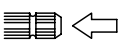

--	--	--	--	--	--	--	--	--	--	--	--

i	r.p.m.	HP	KW	    			ARMADO	ENTRADA	 		
				X	Y	Z			 CODIGO	 CODIGO	
1:1	540	15	11,03	A		A	9	Z	9	180	
1:1	540	15	11,03	A		B	9	Z	9	333	
1:1	540	15	11,03	B		A	9	Z	9	334	
1:1	540	15	11,03	B		B	9	Z	9	335	

