



# CAJA H.385







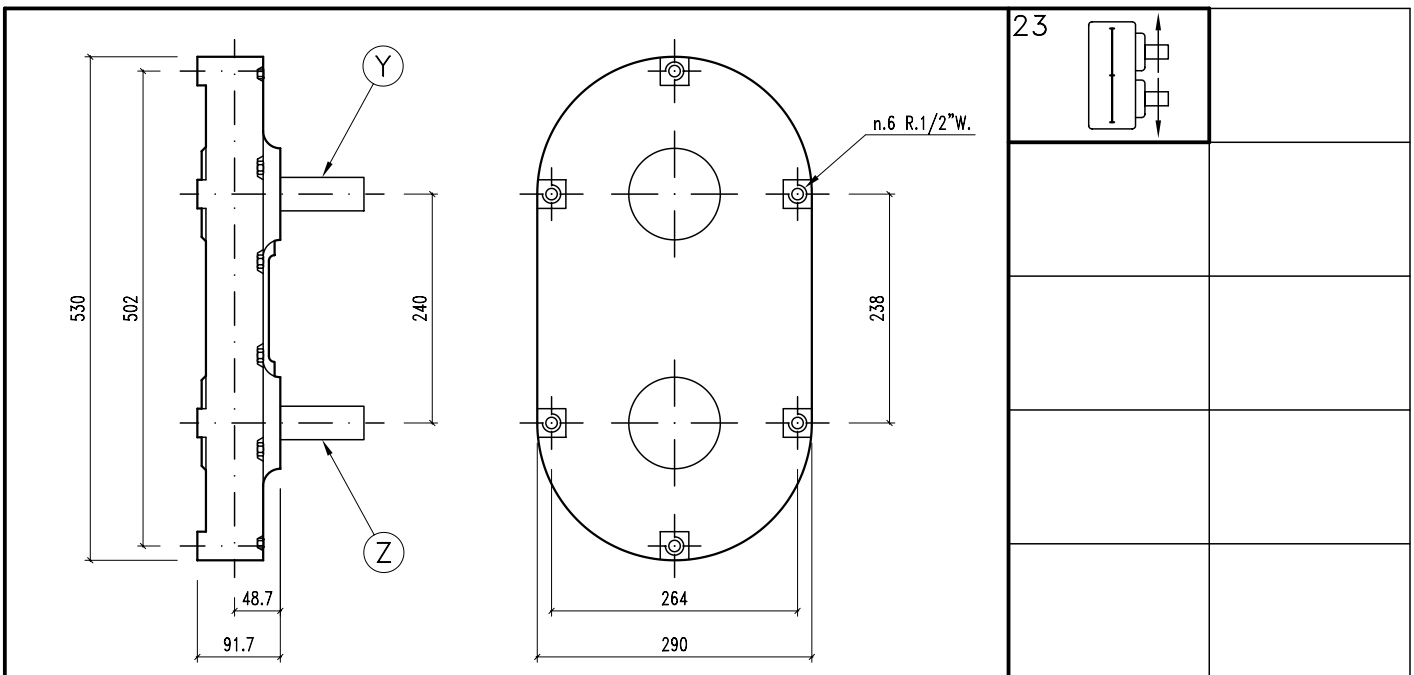
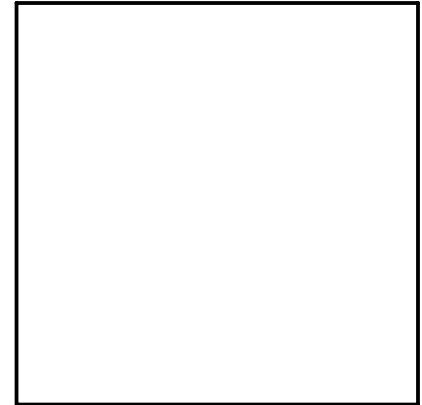

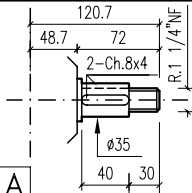

## ALGUNAS POSIBILIDADES DE USO:

- \* Plataforma para cosechadoras.
- \* Transmisiones.

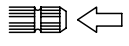
	41
	SAE 90



												
------------------------------------------------------------------------------------	--	--	--	--	--	--	--	--	--	--	--	--

													
	i	r.p.m.	HP	KW	X	Y	Z	ARMADO	ENTRADA		CODIGO		CODIGO
	1:1	540	50	36,78		A	A	23	Y-Z	23	340		

