



CAJA H.386

ALGUNAS POSIBILIDADES DE USO:





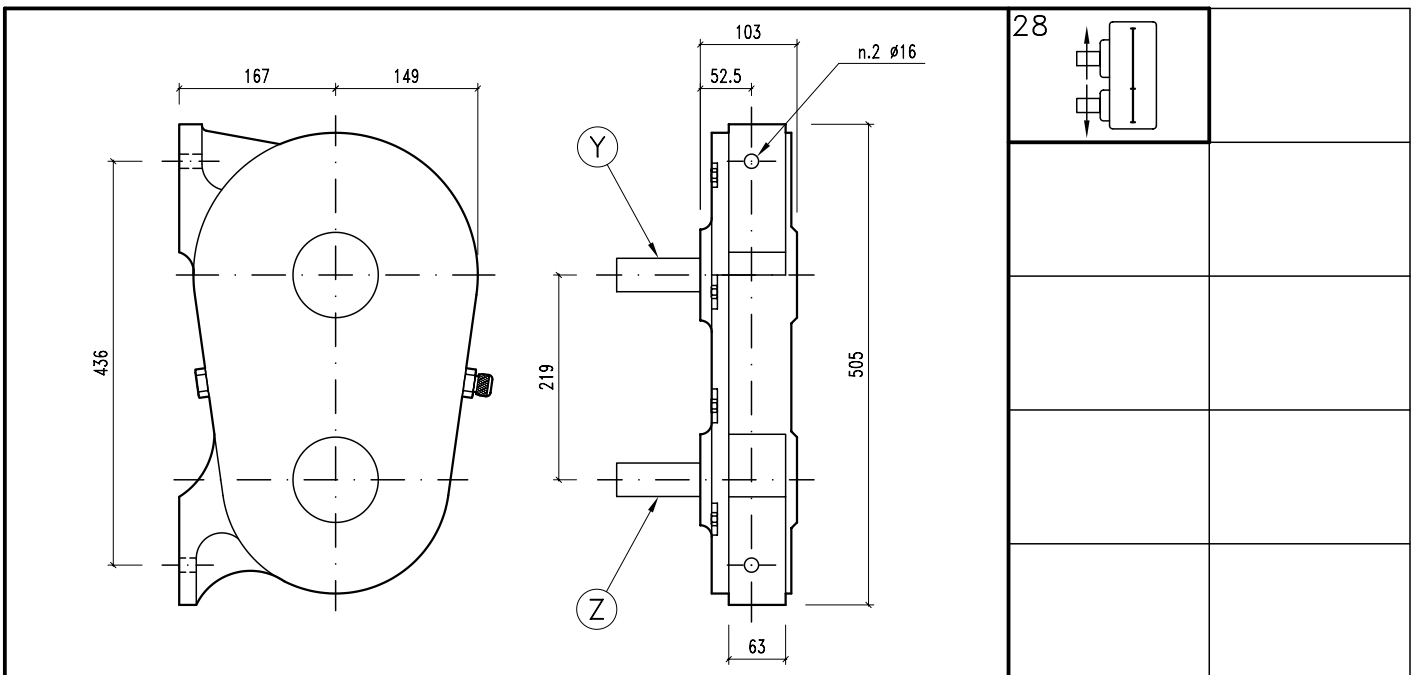
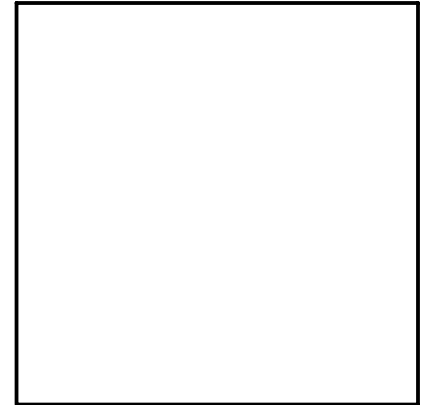

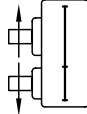

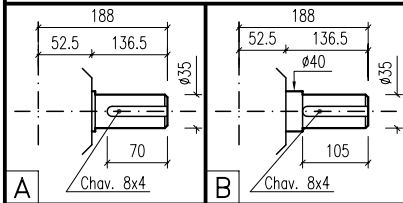

- * Embudidoras de forrajes.
- * Transmisiones.

	49
	SAE 90

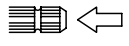

28		



													
	i	r.p.m.	HP	KW	X	Y	Z	ARMADO	ENTRADA		CODIGO		CODIGO
	1,40:1	540	40	29,42		A	B	28	Z	28	432		

