



CAJA H.Y.034-III







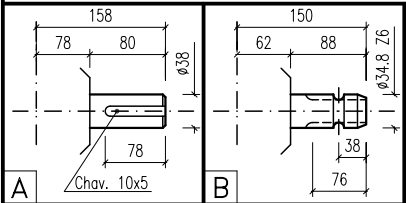
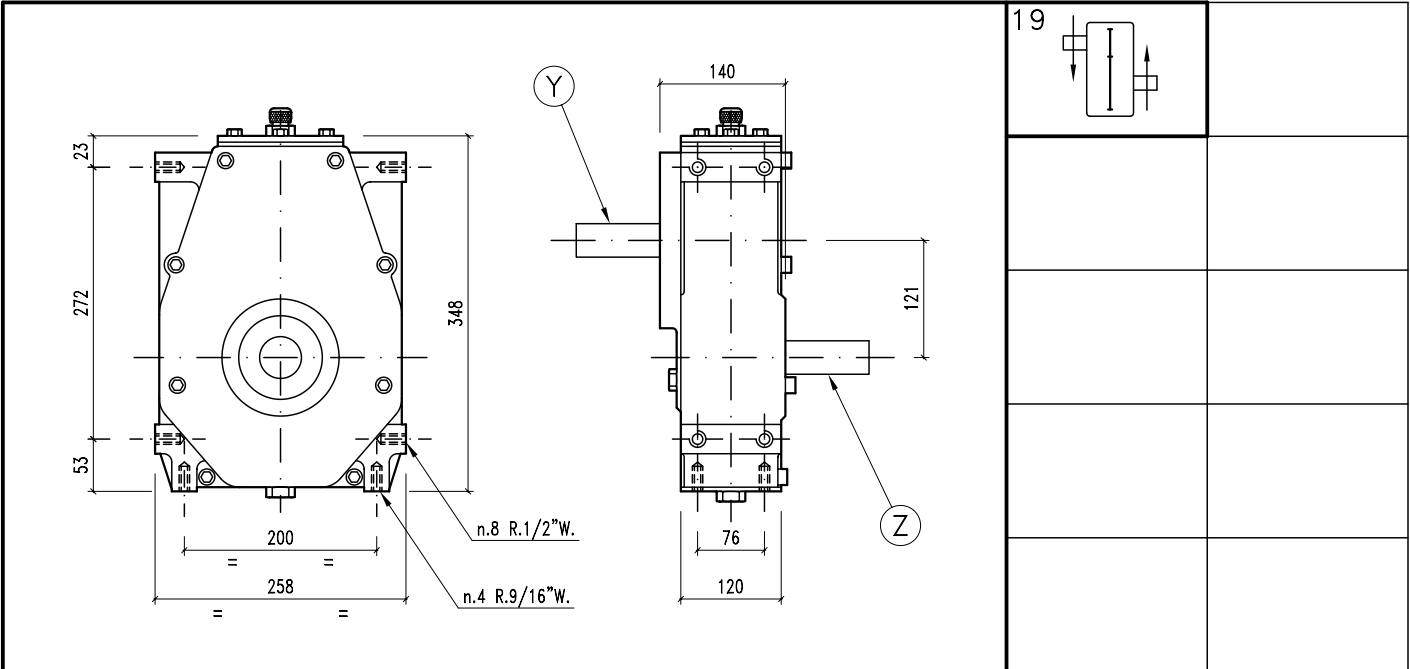
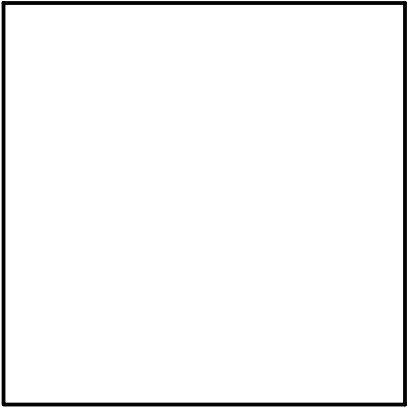

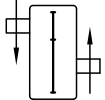

ALGUNAS POSIBILIDADES DE USO:

* Generadores de electricidad.

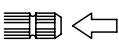
| | |
|---|--------|
|  | 41 |
|  | SAE 90 |



| | |
|---|--|
|  | |
| | |
| | |
| | |
| | |

| |  |  |  |  |  |  |  | | | | | | |
|---|---|---|---|---|--|---|---|--------|---------|---|--------|---|--------|
| | i | r.p.m. | HP | KW | X | Y | Z | ARMADO | ENTRADA |  | CODIGO |  | CODIGO |
|  | 1:5,57 | 540 | 70 | 51,49 | | A | B | 19 | Z | 19 | 346 | | |
| | | | | | | | | | | | | | |
| | | | | | | | | | | | | | |
| | | | | | | | | | | | | | |
| | | | | | | | | | | | | | |

