



CAJA I.130 F

ALGUNAS POSIBILIDADES DE USO:

- * Rotoenfardadoras.
- * Arrolladoras.





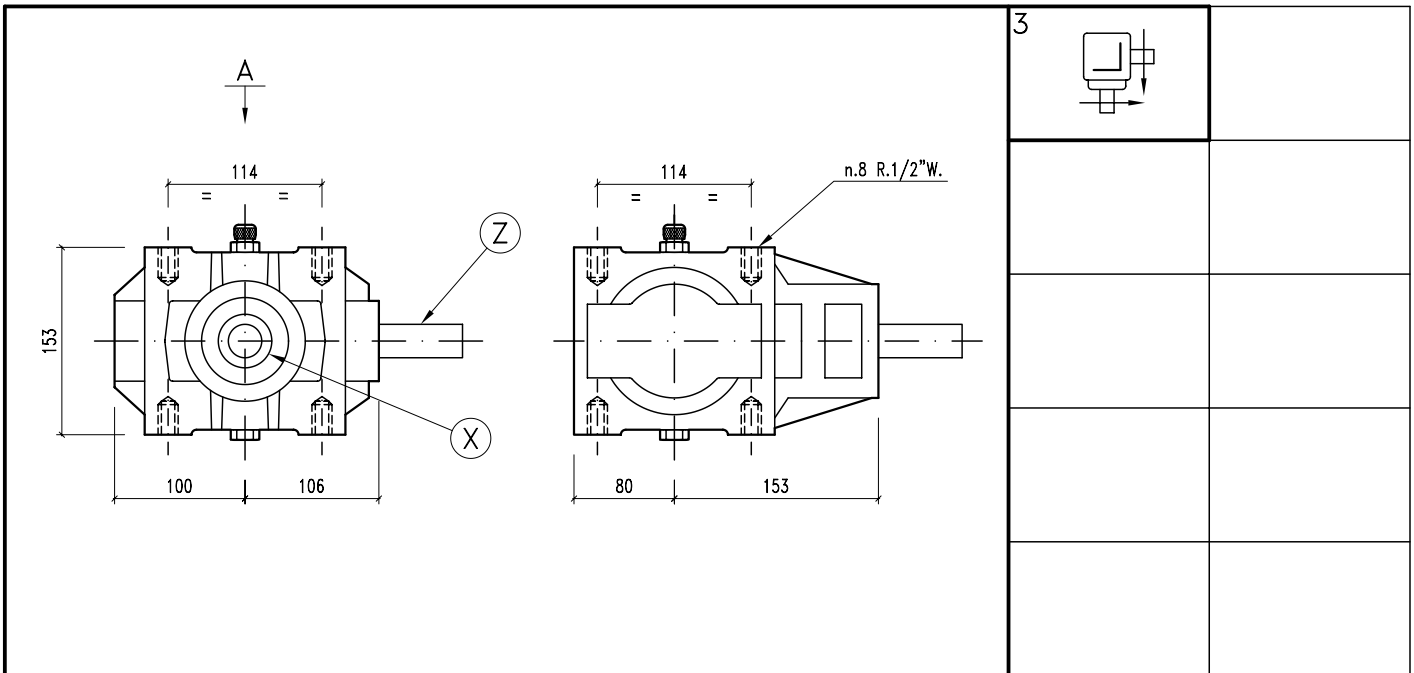



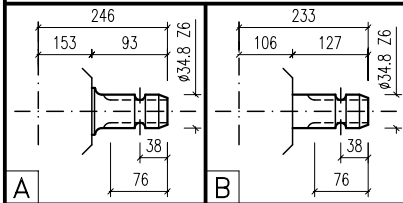

| | |
|---|--------|
|  | 19 |
|  | SAE 90 |

Vista Desde A



| | |
|---|--|
|  | |
| | |
| | |
| | |
| | |



| |  |  |  |  |  |  |  | | | | | | |
|---|---|---|---|---|---|---|---|--------|---------|---|--------|---|--------|
| | i | r.p.m. | HP | KW | X | Y | Z | ARMADO | ENTRADA |  | CODIGO |  | CODIGO |
|  | 1:1,21 | 540 | 32 | 23,54 | A | | B | 3 | X | 3 | 167 | | |
| | 1:1,35 | 540 | 35 | 25,74 | A | | B | 3 | X | 3 | 166 | | |
| | | | | | | | | | | | | | |
|  | 1,21:1 | 540 | 26 | 19,12 | A | | B | 3 | Z | 3 | 167 | | |
| | 1,35:1 | 540 | 21 | 15,45 | A | | B | 3 | Z | 3 | 166 | | |

