



CAJA M.127-30-3T

ALGUNAS POSIBILIDADES DE USO:

- * Inversora de giro.
- * Usos especiales.



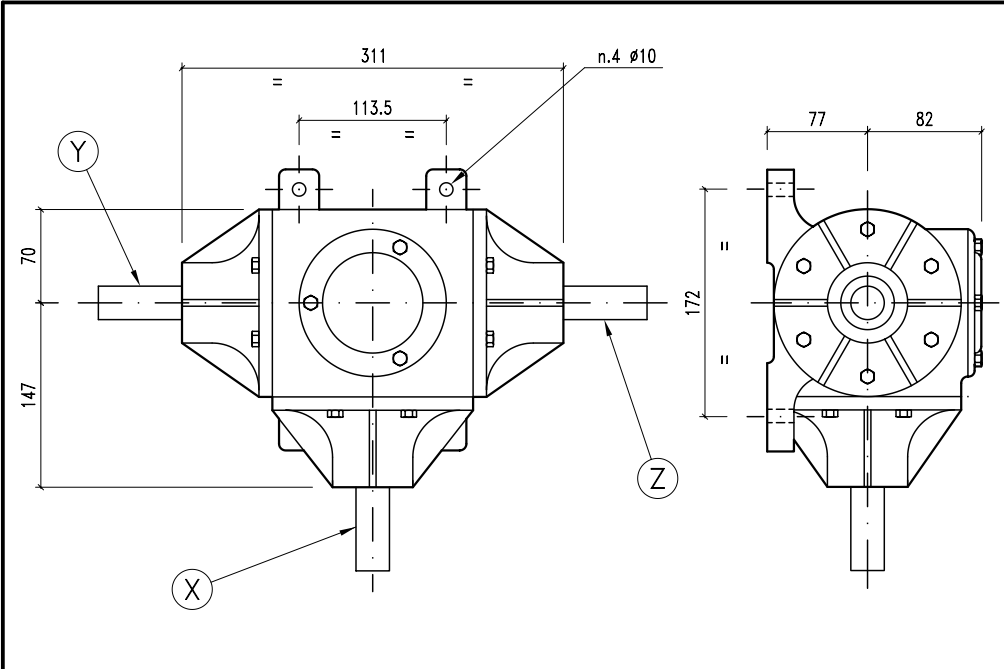
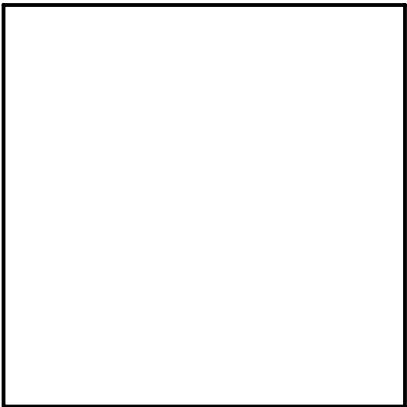

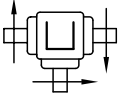
	21,5
	SAE 90

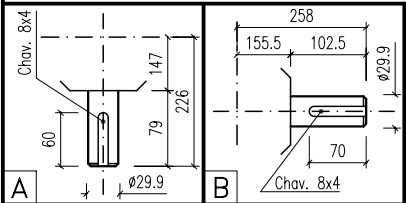



--	--	--	--	--	--	--	--	--	--	--	--

i	r.p.m.	HP	KW	X Y Z			ARMADO	ENTRADA	CODIGO		
											
1:1	540	20	14,71	A	B	B	31	X-Y-Z	31	457	
1:1,77	540	32	23,54	A	B	B	31	X	31	458	
1,77:1	540	11	8,09	A	B	B	31	Y-Z	31	458	

