





CAJA M.128-25P

ALGUNAS POSIBILIDADES DE USO:



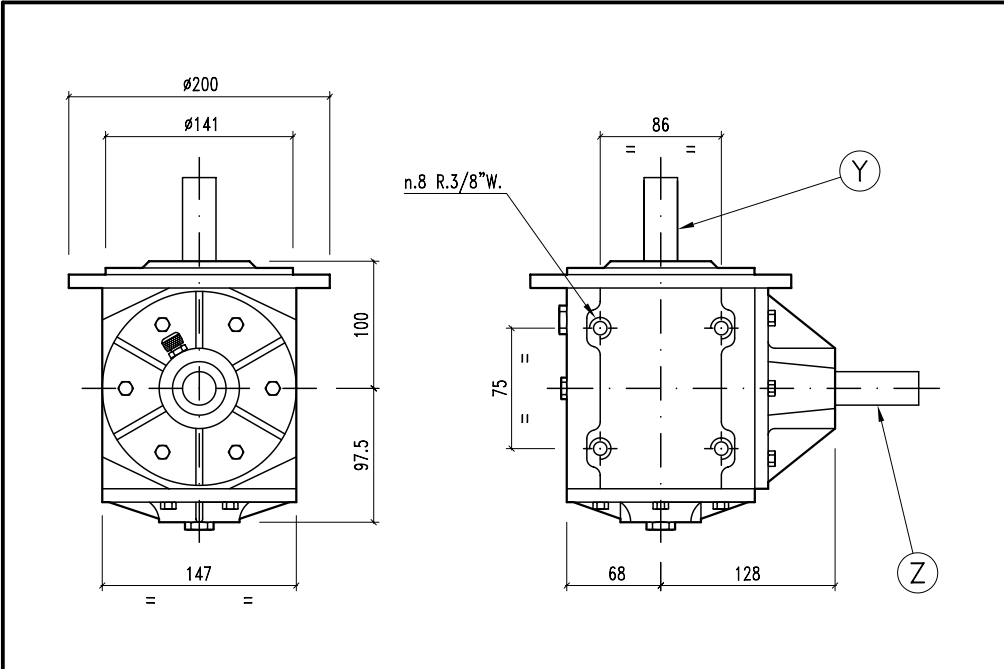
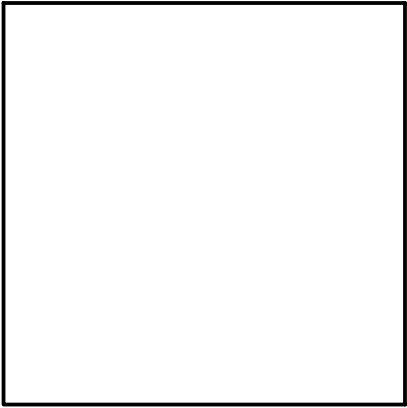

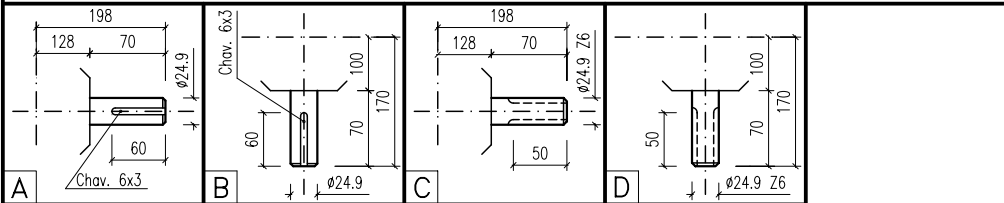

* Acoplados tolva autodescargables.

	17
	SAE 90





i	r.p.m.	HP	KW	X Y Z			ARMADO	ENTRADA	CODIGO			
												
1:1	540	15	11,03		B	A	3-6	Z	3	381	6	382
1:1	540	15	11,03		B	C	3-6	Z	3	383	6	384
1:1	540	15	11,03		D	A	3-6	Z	3	393	6	394
1:1	540	15	11,03		D	C	3-6	Z	3	395	6	396

