



CAJA M.128-30M

ALGUNAS POSIBILIDADES DE USO:

- * Elevadores de granos a sin fin.
- * Carros tolva.

	20
	SAE 90

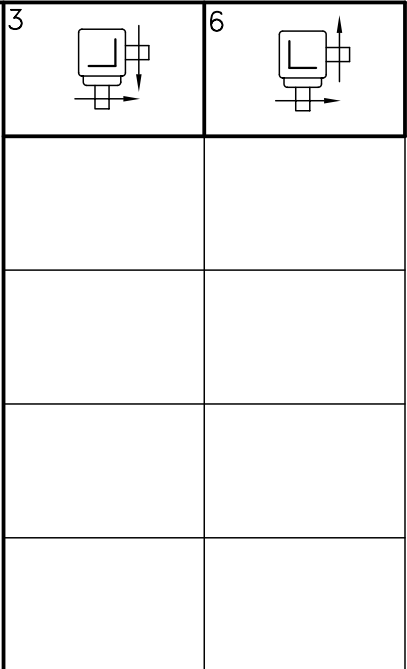
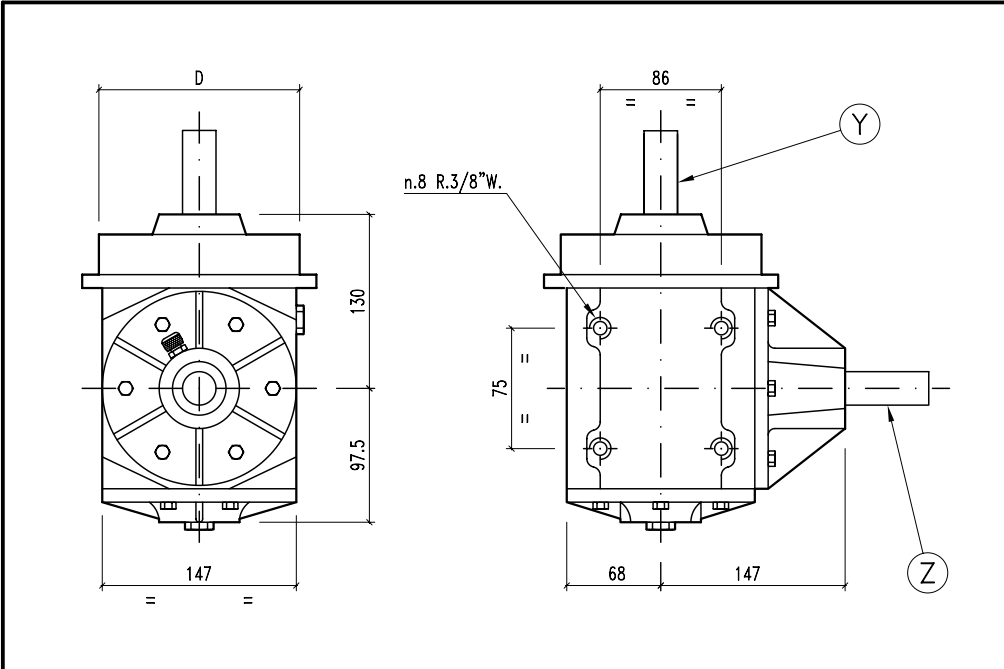
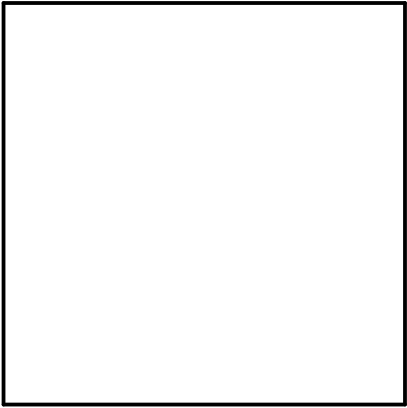

--	--	--	--	--	--	--	--

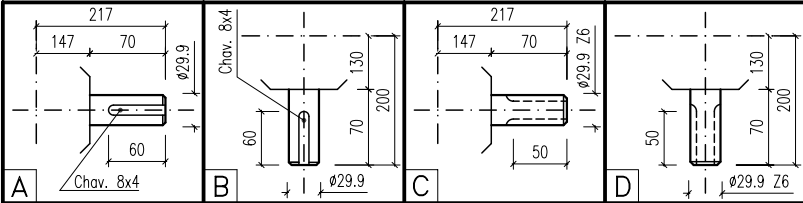









--	--	--	--	--	--	--	--

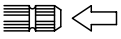

GARRO FABRIL S.A.

--	--

CAJA M.128-30M

													
i	r.p.m.	HP	KW	X	Y	Z	ARMADO	ENTRADA	D		CODIGO		CODIGO
1:1	540	20	14,71		B	A	3-6	Z	160	3	365	6	366
1:1	540	20	14,71		B	C	3-6	Z	160	3	367	6	368
1:1	540	20	14,71		D	A	3-6	Z	160	3	413	6	414
1:1	540	20	14,71		D	C	3-6	Z	160	3	415	6	416
1:1	540	20	14,71		B	A	3-6	Z	180	3	369	6	370
1:1	540	20	14,71		B	C	3-6	Z	180	3	371	6	372
1:1	540	20	14,71		D	A	3-6	Z	180	3	417	6	418
1:1	540	20	14,71		D	C	3-6	Z	180	3	419	6	420
1:1	540	20	14,71		B	A	3-6	Z	200	3	373	6	374
1:1	540	20	14,71		B	C	3-6	Z	200	3	375	6	376
1:1	540	20	14,71		D	A	3-6	Z	200	3	421	6	422
1:1	540	20	14,71		D	C	3-6	Z	200	3	423	6	424
1:1	540	20	14,71		B	A	3-6	Z	210	3	377	6	378
1:1	540	20	14,71		B	C	3-6	Z	210	3	379	6	380
1:1	540	20	14,71		D	A	3-6	Z	210	3	425	6	426
1:1	540	20	14,71		D	C	3-6	Z	210	3	427	6	428



	 GARRO FABRIL S.A.		