





CAJA M.128-30P

ALGUNAS POSIBILIDADES DE USO:



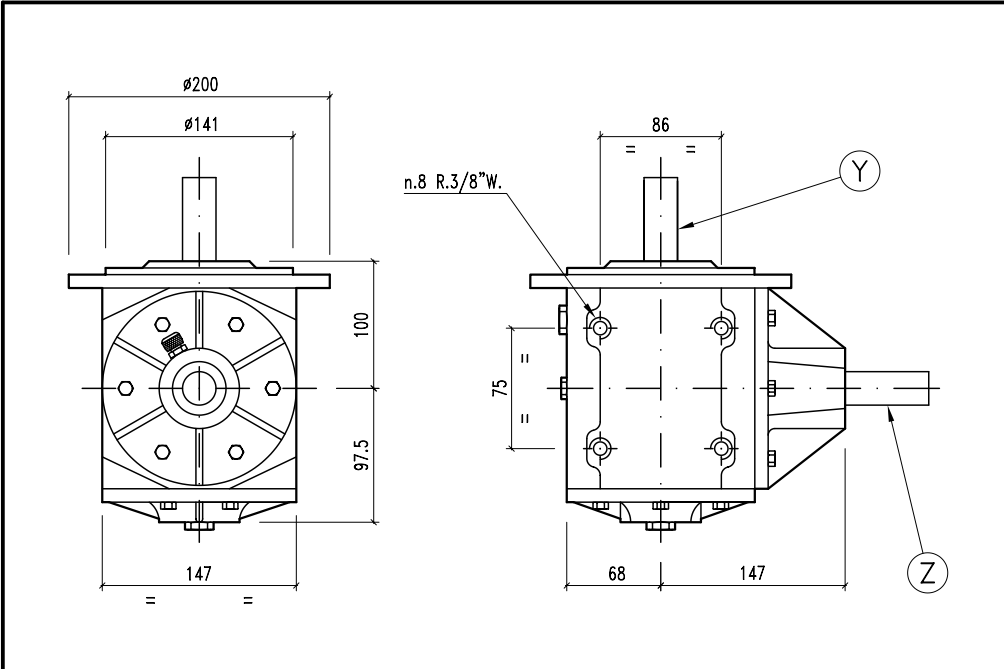
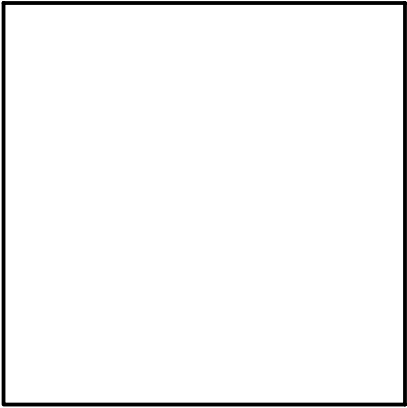

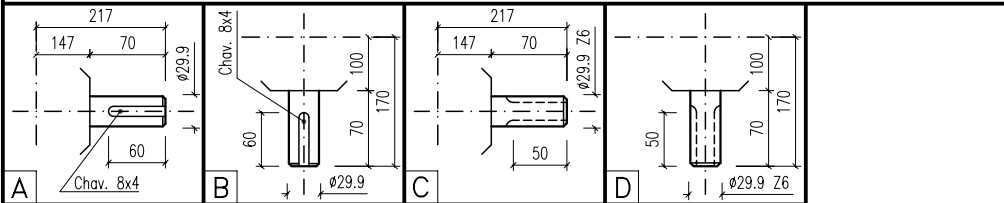

* Acoplados tolva autodescargables.

	19
	SAE 90





i	r.p.m.	HP	KW	X Y Z			ARMADO	ENTRADA	CODIGO			
												
1:1	540	20	14,71		B	A	3-6	Z	3	385	6	386
1:1	540	20	14,71		B	C	3-6	Z	3	387	6	388
1:1	540	20	14,71		D	A	3-6	Z	3	389	6	390
1:1	540	20	14,71		D	C	3-6	Z	3	391	6	392

