





CAJA M.236-C





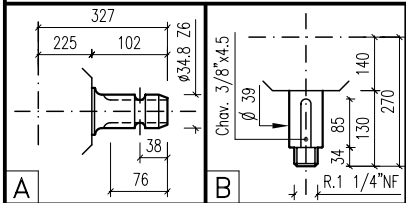
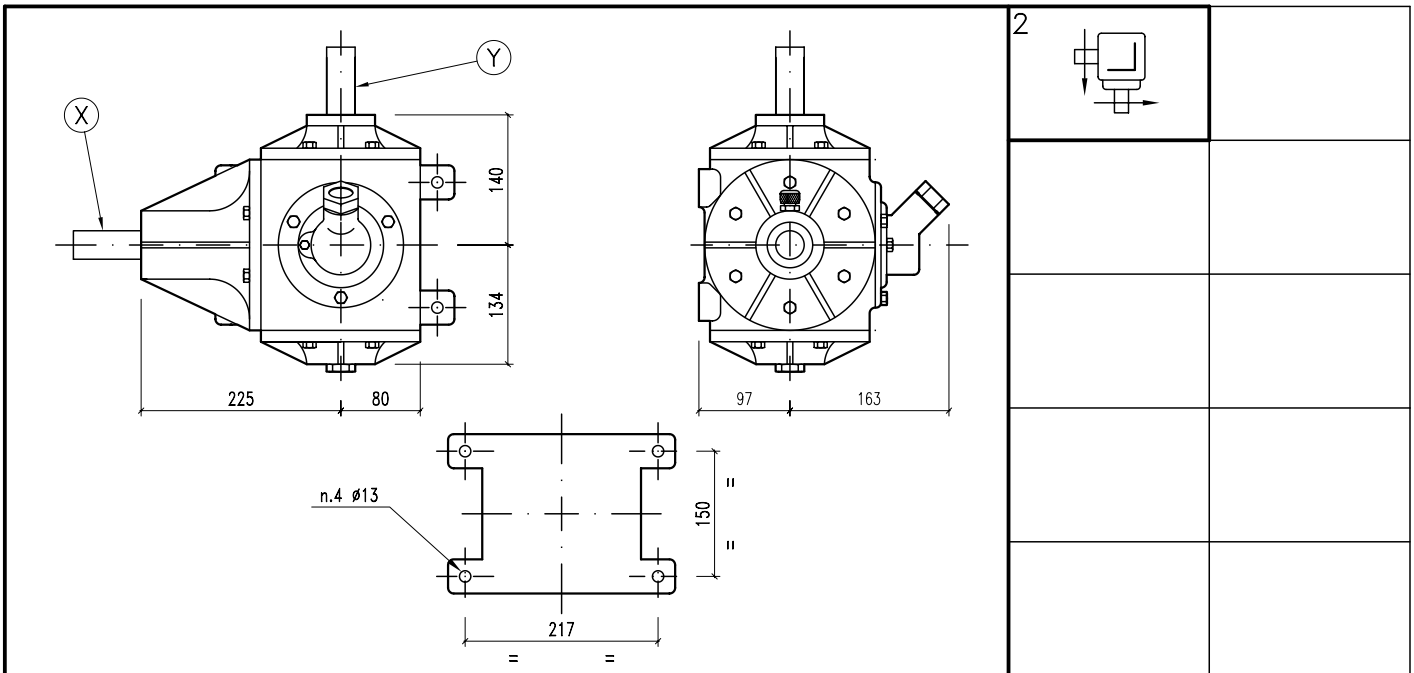





ALGUNAS POSIBILIDADES DE USO:

* Desmalezadora-hileradora.

	35
	SAE 90



													
	i	r.p.m.	HP	KW	X	Y	Z	ARMADO	ENTRADA		CODIGO		CODIGO
	1:1	540	45	33,10	A	B		2	X	2	96		

