



CAJA M.236

ALGUNAS POSIBILIDADES DE USO:

- * Elevadores de granos a sin fin.
- * Acoplados tolva autodescargables.
- * Transmisiones.

	31,5
	SAE 90

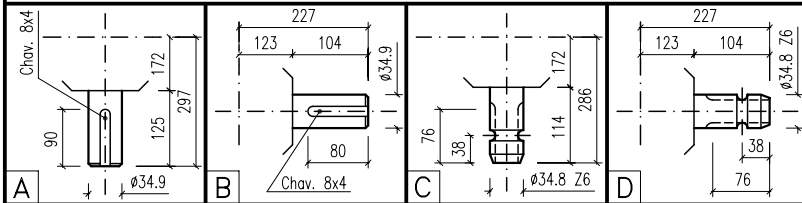
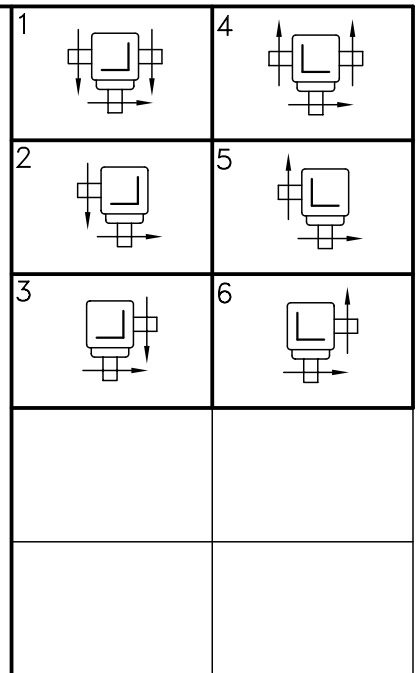
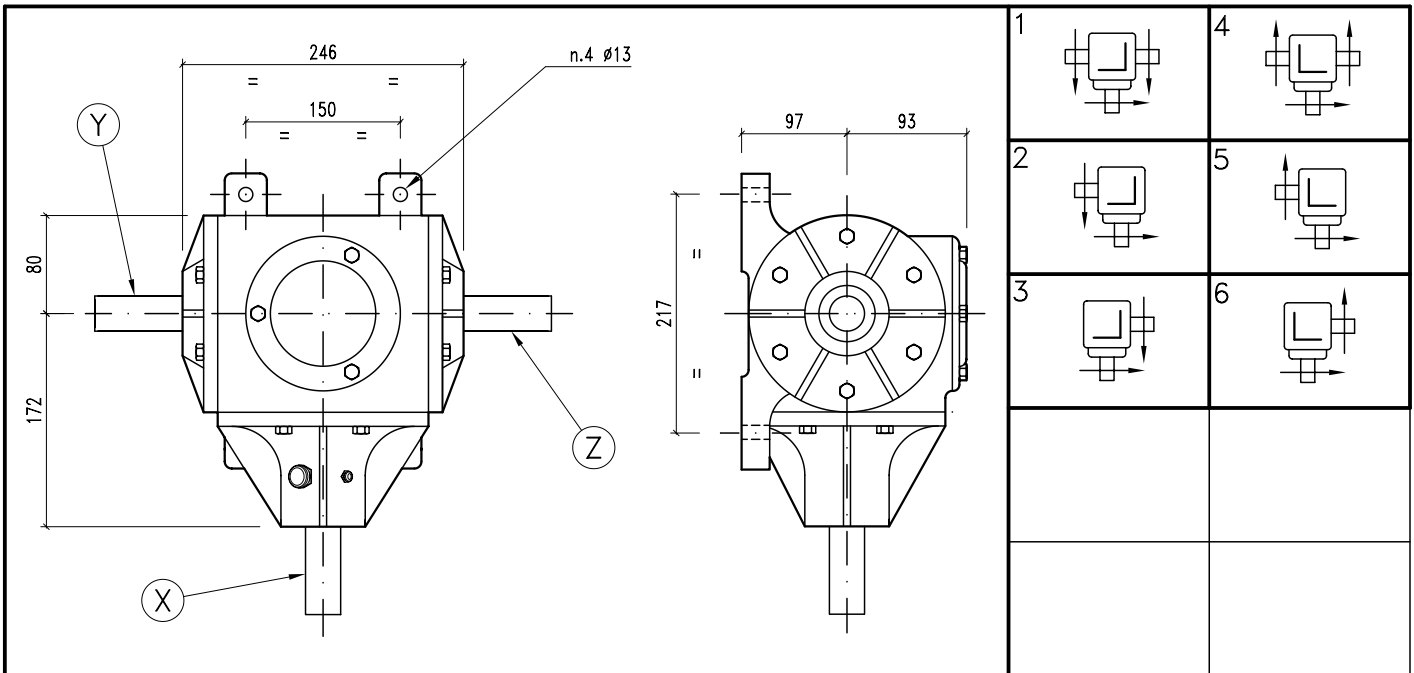



i	r.p.m.	HP	KW	MOUNTING POINTS			ARMADO	ENTRADA	CODIGO	CODIGO		
				X	Y	Z						
1:1	540	45	33,10	A	B	B	1-4	X-Y-Z	1	28-A	4	28-B
1:1	540	45	33,10	C	B	B	1-4	X-Y-Z	1	30-A	4	30-B
1:1	540	45	33,10	A	B		2-5	X-Y	2	87-A	5	88-B
1:1	540	45	33,10	A		B	3-6	X-Z	3	88-A	6	87-B
1:1	540	45	33,10	C	B		2-5	X-Y	2	89-A	5	92-B
1:1	540	45	33,10	C		B	3-6	X-Z	3	92-A	6	89-B
1:1	540	45	33,10	A	D		2-5	X-Y	2	90-A	5	93-B



GARRO FABRIL S.A.

CAJA M.236

i	r.p.m.	HP	KW	X	Y	Z	ARMADO	ENTRADA		CODIGO		CODIGO
1:1	540	45	33,10	A		D	3-6	X-Z	3	93-A	6	90-B
1:1	540	45	33,10	C	D		2-5	X-Y	2	91-A	5	94-B
1:1	540	45	33,10	C		D	3-6	X-Z	3	94-A	6	91-B
1:1	540	45	33,10	A	D	B	1-4	X-Y-Z	1	209-A	4	211-B
1:1	540	45	33,10	A	D	D	1-4	X-Y-Z	1	210-A	4	210-B
1:1	540	45	33,10	A	B	D	1-4	X-Y-Z	1	211-A	4	209-B
1:1	540	45	33,10	C	D	B	1-4	X-Y-Z	1	212-A	4	214-B
1:1	540	45	33,10	C	D	D	1-4	X-Y-Z	1	213-A	4	213-B
1:1	540	45	33,10	C	B	D	1-4	X-Y-Z	1	214-A	4	212-B
1:1,5	540	50	36,78	A	B	B	1-4	X	1	25-A	4	25-B
1:1,5	540	50	36,78	C	B	B	1-4	X	1	29-A	4	29-B
1:1,5	540	50	36,78	A	B		2-5	X	2	26-A	5	27-B
1:1,5	540	50	36,78	A		B	3-6	X	3	27-A	6	26-B
1:1,5	540	50	36,78	C	B		2-5	X	2	31-A	5	34-B
1:1,5	540	50	36,78	C		B	3-6	X	3	34-A	6	31-B
1:1,5	540	50	36,78	A	D		2-5	X	2	32-A	5	35-B
1:1,5	540	50	36,78	A		D	3-6	X	3	35-A	6	32-B
1:1,5	540	50	36,78	C	D		2-5	X	2	33-A	5	36-B
1:1,5	540	50	36,78	C		D	3-6	X	3	36-A	6	33-B
1:1,5	540	50	36,78	A	D	B	1-4	X	1	203-A	4	205-B
1:1,5	540	50	36,78	A	D	D	1-4	X	1	204-A	4	204-B
1:1,5	540	50	36,78	A	B	D	1-4	X	1	205-A	4	203-B
1:1,5	540	50	36,78	C	D	B	1-4	X	1	206-A	4	208-B
1:1,5	540	50	36,78	C	D	D	1-4	X	1	207-A	4	207-B
1:1,5	540	50	36,78	C	B	D	1-4	X	1	208-A	4	206-B
1,5:1	540	40	29,42	A	B	B	1-4	Y-Z	1	25-A	4	25-B
1,5:1	540	40	29,42	C	B	B	1-4	Y-Z	1	29-A	4	29-B
1,5:1	540	40	29,42	A	B		2-5	Y	2	26-A	5	27-B
1,5:1	540	40	29,42	A		B	3-6	Z	3	27-A	6	26-B
1,5:1	540	40	29,42	C	B		2-5	Y	2	31-A	5	34-B
1,5:1	540	40	29,42	C		B	3-6	Z	3	34-A	6	31-B
1,5:1	540	40	29,42	A	D		2-5	Y	2	32-A	5	35-B
1,5:1	540	40	29,42	A		D	3-6	Z	3	35-A	6	32-B
1,5:1	540	40	29,42	C	D		2-5	Y	2	33-A	5	36-B
1,5:1	540	40	29,42	C		D	3-6	Z	3	36-A	6	33-B
1,5:1	540	40	29,42	A	D	B	1-4	Y-Z	1	203-A	4	205-B
1,5:1	540	40	29,42	A	D	D	1-4	Y-Z	1	204-A	4	204-B
1,5:1	540	40	29,42	A	B	D	1-4	Y-Z	1	205-A	4	203-B
1,5:1	540	40	29,42	C	D	B	1-4	Y-Z	1	206-A	4	208-B
1,5:1	540	40	29,42	C	D	D	1-4	Y-Z	1	207-A	4	207-B
1,5:1	540	40	29,42	C	B	D	1-4	Y-Z	1	208-A	4	206-B

