



CAJA M.237-CVII

ALGUNAS POSIBILIDADES DE USO:



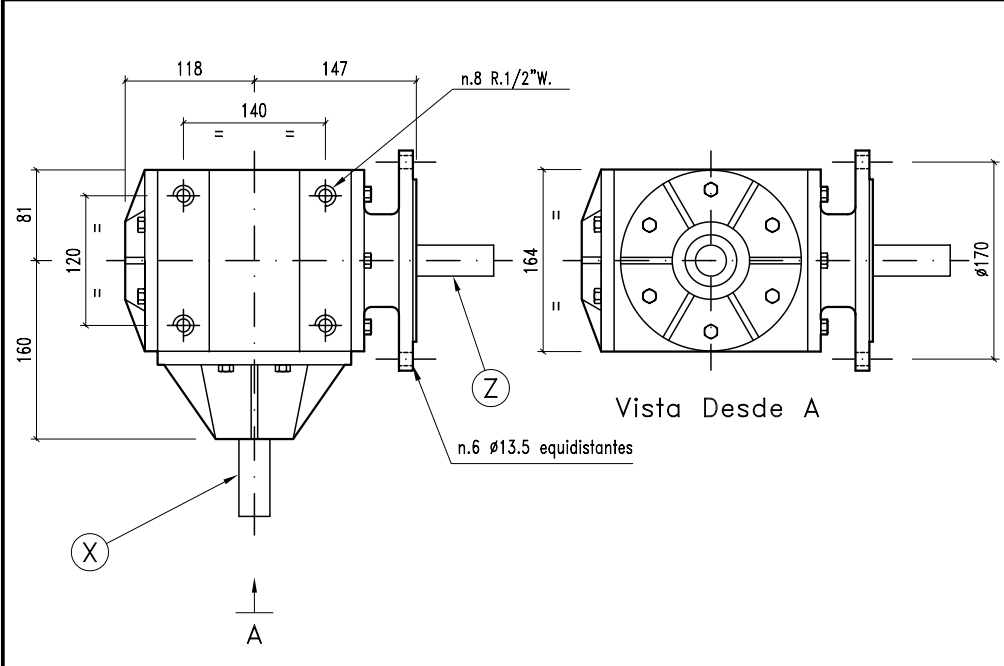
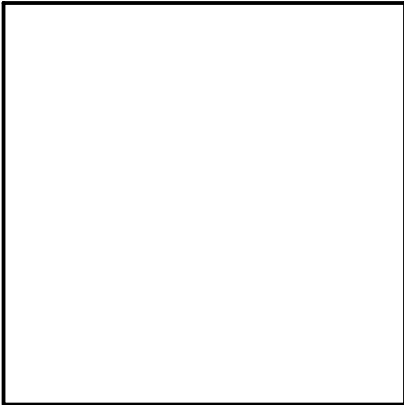

* Acoplados tolva.

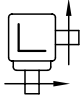
	31
	SAE 90

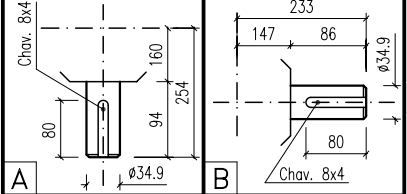

6		



i	r.p.m.	HP	KW	X Y Z			ARMADO	ENTRADA	CODIGO			
												
1:1	540	45	33,10	A		B	6	X	6	447		

