



CAJA M.237

ALGUNAS POSIBILIDADES DE USO:

- * Acoplados tolva autodescargables.
- * Transmisiones.

	28
	SAE 90

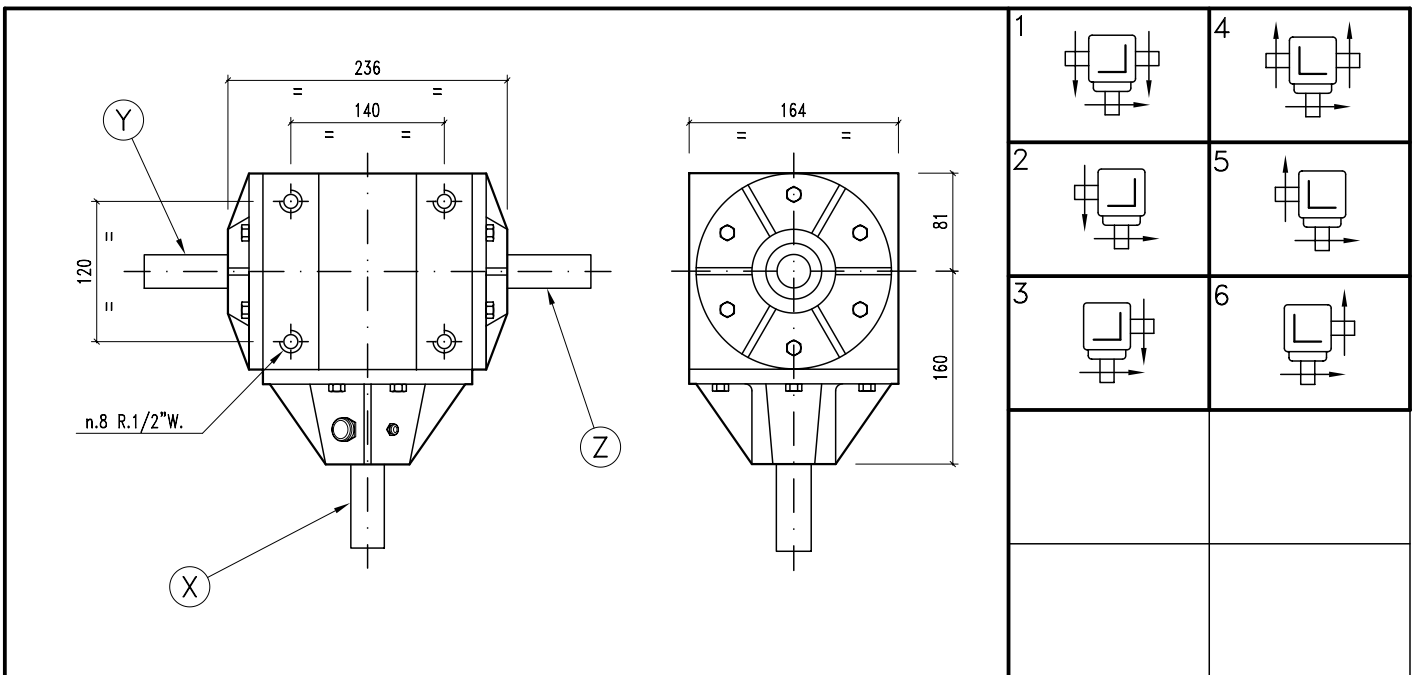
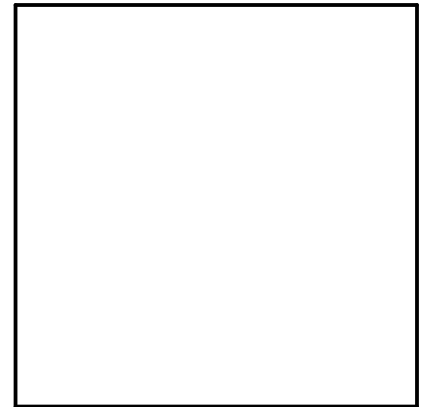



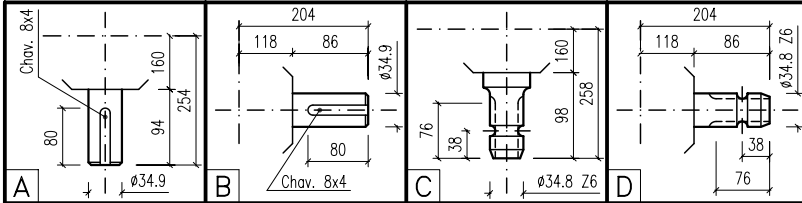





--	--	--	--	--	--



--	--	--	--	--	--

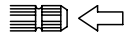

CAJA M.237

												
i	r.p.m.	HP	KW	X	Y	Z	ARMADO	ENTRADA		CODIGO		CODIGO
1:1	540	45	33,10	A	B	B	1-4	X-Y-Z	1	37-A	4	37-B
1:1	540	45	33,10	C	B	B	1-4	X-Y-Z	1	38-A	4	38-B
1:1	540	45	33,10	A	B		2-5	X-Y	2	39-A	5	40-B
1:1	540	45	33,10	A		B	3-6	X-Z	3	40-A	6	39-B
1:1	540	45	33,10	C	B		2-5	X-Y	2	41-A	5	44-B
1:1	540	45	33,10	A	D		2-5	X-Y	2	42-A	5	45-B
1:1	540	45	33,10	C	D		2-5	X-Y	2	43-A	5	46-B
1:1	540	45	33,10	C		B	3-6	X-Z	3	44-A	6	41-B
1:1	540	45	33,10	A		D	3-6	X-Z	3	45-A	6	42-B
1:1	540	45	33,10	C		D	3-6	X-Z	3	46-A	6	43-B
1:1,5	540	50	36,76	A	B	B	1-4	X	1	460-A	4	460-B
1,5:1	540	40	29,46	A	B	B	1-4	Y-Z	1	460-A	4	460-B



 GARRO FABRIL S.A.					