











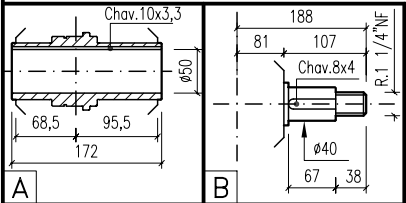
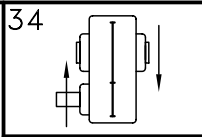
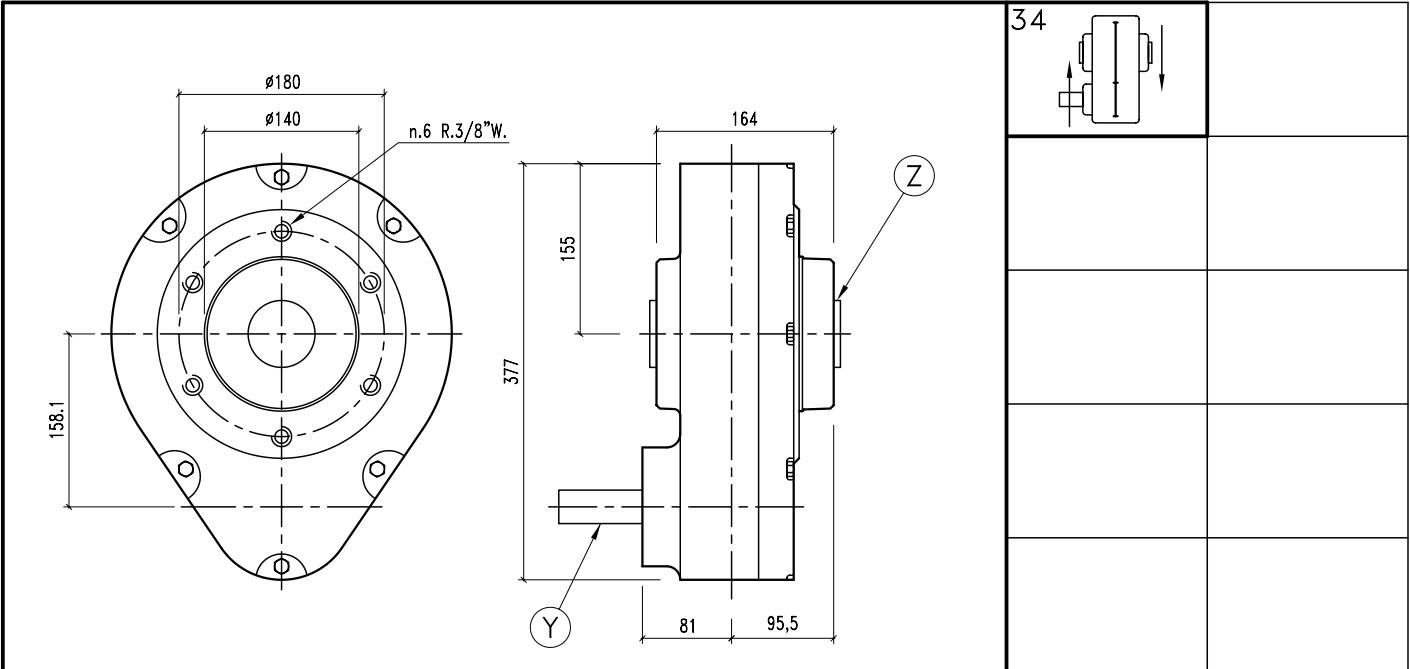
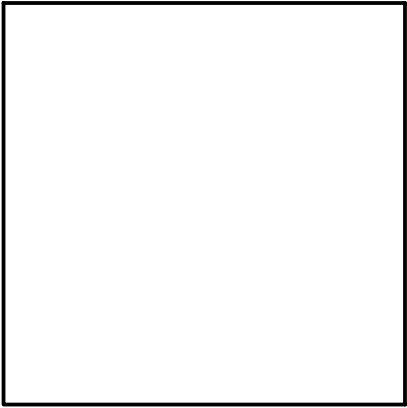

# CAJA P 15-30 120

**ALGUNAS POSIBILIDADES DE USO:**

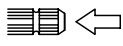
\* Cintas transportadoras

	38,5
	SAE 90



													
	i	r.p.m.	HP	KW	X	Y	Z	ARMADO	ENTRADA		CODIGO		CODIGO
	4,22:1	540	30	22,07		B	A	34	Y	34	668		

