



CABEZAL Z.K.001







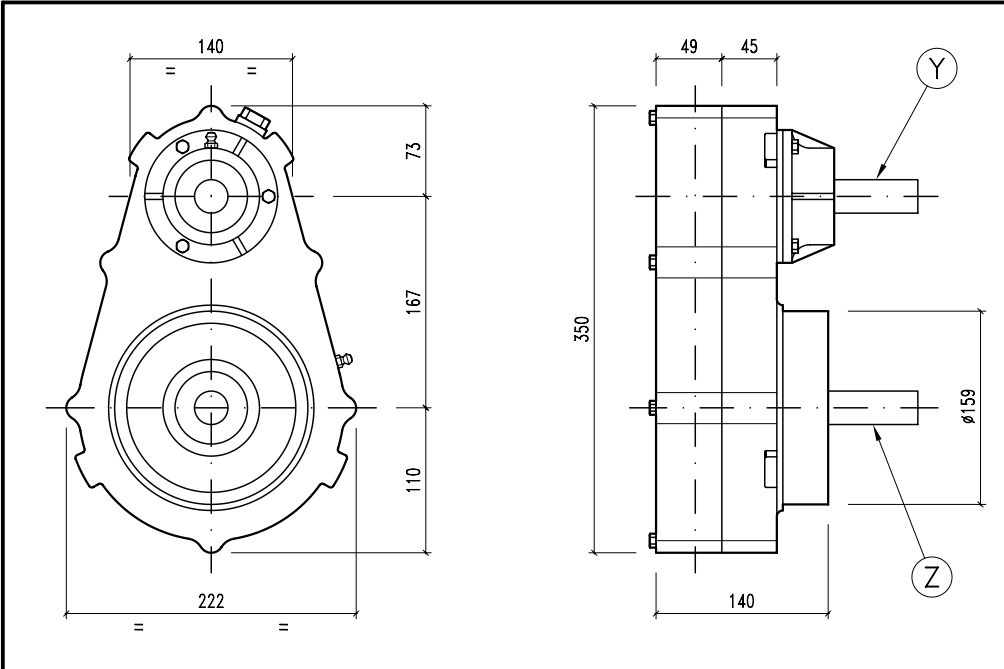
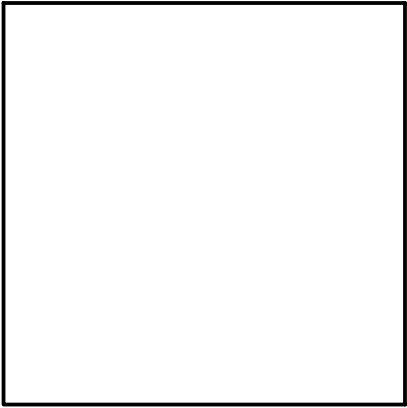
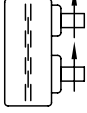

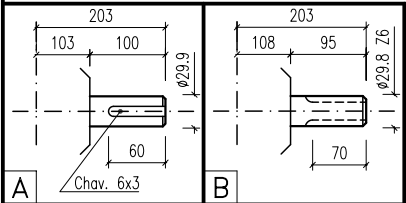

ALGUNAS POSIBILIDADES DE USO:
 * Elevadores de granos a sin fin.

	18,5
	SAE 90



11		



														
	i	r.p.m.	HP	KW	X	Y	Z	ARMADO	ENTRADA	PASO		CODIGO		CODIGO
	2:1	540	30	22,07		B	A	11	Y	3/4"	11	141		

